

**MOUNT JOY TOWNSHIP  
ZONING HEARING BOARD**

**JANUARY 17, 2023**

**PDC Northeast LPIV, LLC (Panattoni Development Company)**

**TABLE OF EXHIBITS**

- A-1.....ZONING APPLICATION**
- A-2.....JERAMY BITTINGER RESUME**
- A-3.....AERIAL MAP OF PROPERTY**
- A-4.....CONCEPT PLAN WITH POTENTIAL FUTURE BUILDING**
- A-5.....LANDSCAPE AND LIGHTING PLAN**
- A-6.....LIGHTING DETAILS SHEET**
- A-7.....PERFORMANCE REPORT BY LANDWORKS CIVIL DESIGN**
- A-8.....BUILDING RENDERING**
- A-9.....BUILDING ELEVATIONS**
- A-10.....CONDITIONS OF APPROVAL**
- A-11.....JARRED NEAL RESUME**
- A-12.....TPD LETTER DATED 12/22/22**
- A-13.....STEEL WAY/CLOVERLEAF ROAD IMPROVEMENT PLAN DATED 1/11/23**

# Jeremy Bittinger, E.I.T.

## Project Manager

---

### EDUCATION

**Bachelor of Science, 2018**  
Civil Engineering Technology  
University of Pittsburg at Johnstown

### REGISTRATIONS

Engineer-in-Training, PA

### SKILLS

Project Management  
Conceptual Site Plans  
Site Grading  
Stormwater Management  
Erosion & Sedimentation Control  
Construction Cost Analysis  
Construction Inspection

### PROFESSIONAL PROFILE

Jeremy Bittinger is a Project Manager at Landworks Civil Design, LLC. For more than five years, Mr. Bittinger has honed his skills in land development design, specializing in Project Management, Conceptual Site Planning, and Land Development Permitting. Working directly with property owners and developers, Mr. Bittinger has a wide range of experience covering all aspects of the land development industry.

Geographically, Mr. Bittinger has worked throughout southcentral, eastern, and northeast Pennsylvania. With a focus on warehouse development in the industrial sector, Mr. Bittinger has experience throughout the entire length of the I-78, I-81, and I-83 corridors within Pennsylvania.

### Representative Projects

**UPS Northeast Regional Hub, Dauphin County, PA**

775,433 SF parcel distribution and delivery facility

**D&H Middletown, Dauphin County, PA**

745,200 SF warehousing facility

**CORE5 at Codorus Creek, York County, PA**

1.4M SF industrial park for various tenants

**Goodman Logistics Center (Newberry), York County, PA**

1.0 M SF industrial park for various tenants

**Rausch Creek Logistics Center, Schuylkill County, PA**

2.3M SF industrial park for various tenants

**Matrix I-81 Logistics Center, Franklin County, PA**

1.5MM SF industrial park for various tenants

**Jednota Estates, Dauphin County, PA**

150 lot residential subdivision

**Wilshire Estates, Dauphin County, PA**

107 lot residential subdivision

**Ridgeview Apartments, Dauphin County, PA**

80 unit apartment complex

**Woodspring Suites Hotel, Philadelphia County, PA**

122 room hotel



# Aerial Map

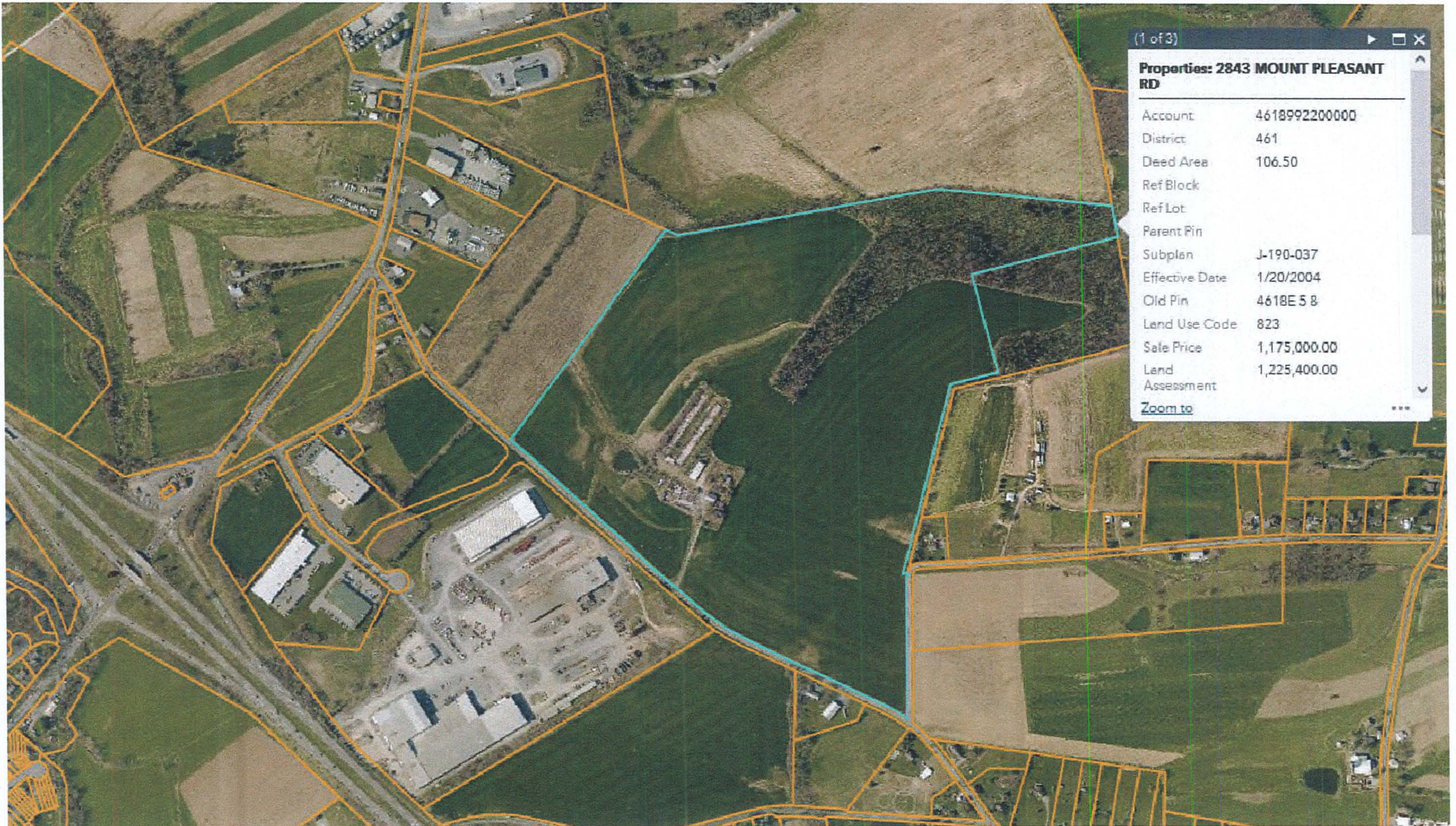

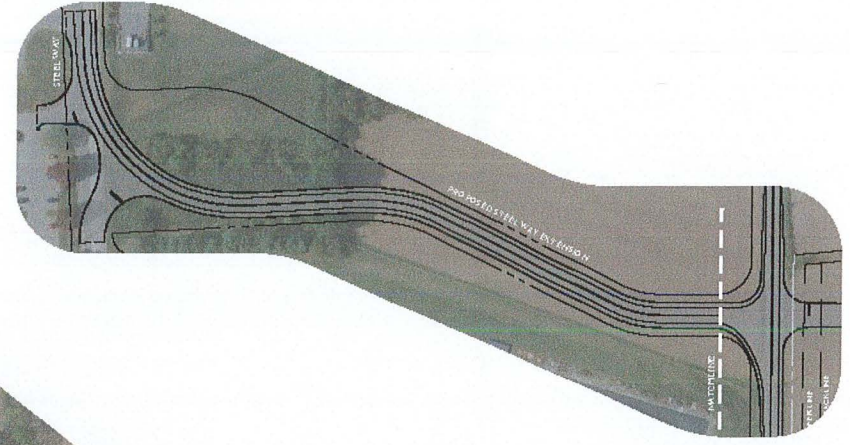
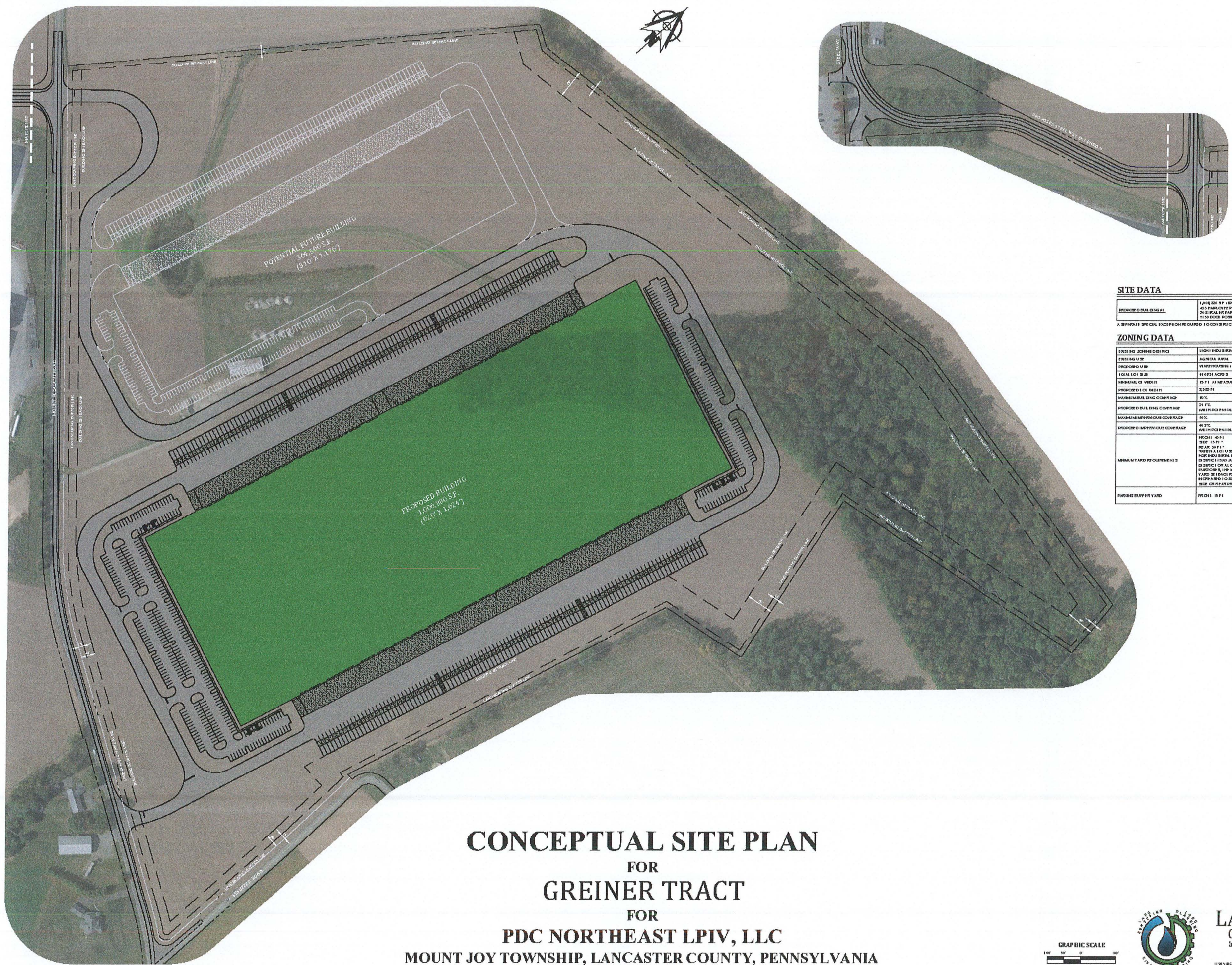

**SITE DATA**

PROPOSED BUILDING #1	1,004,980 S.F. (28' x 35,147' x 1,004,980 S.F.)
PROPOSED BUILDING #2	369,500 S.F. (310' x 1,176')
A SEPARATE SPECIAL EXCEPTION REQUIRED TO CONSTRUCT POTENTIAL FUTURE BUILDING	

**ZONING DATA**

EXISTING ZONING DISTRICT	LIGHT INDUSTRIAL
EXISTING USE	AGRICULTURE
PROPOSED USE	INDUSTRIAL / SPECIAL EXCEPTION
LOCAL LOT SIZE	11.0531 ACRES
MINIMUM LOT WIDTH	12 FT. AT MEASUREMENT BACKLINE
PROPOSED LOT WIDTH	233 FT.
MINIMUM SETBACK	21 FT.
PROPOSED SETBACK	21 FT. WITH POTENTIAL FUTURE BUILDING 30 FT.
MAXIMUM IMPERVIOUS COVERAGE	10%
PROPOSED IMPERVIOUS COVERAGE	10% WITH POTENTIAL FUTURE BUILDING 35%.
MINIMUM YARD REQUIREMENTS	FRONT 40 FT. SIDE 10 FT. REAR 30 FT. WHEN A LOT USED OR PROPOSED FOR USE FOR A PURPOSE OTHER THAN THE DISTRICT'S INTENDED USE OR FOR A PURPOSE OTHER THAN THE DISTRICT'S INTENDED USE, THE MINIMUM SETBACK AND REAR YARD SETBACKS FOR OVERHANGING SIGNAGE SHALL BE INCREASED TO 10 FT. FROM EACH ADJACENT SIDE OR REAR PROPERTY LINE.
PARKING BUFFER YARD	FRONT 10 FT.

**CONCEPTUAL SITE PLAN**  
 FOR  
**GREINER TRACT**  
 FOR  
**PDC NORTHEAST LP IV, LLC**  
 MOUNT JOY TOWNSHIP, LANCASTER COUNTY, PENNSYLVANIA



**LANDWORKS**  
 CIVIL DESIGN, LLC  
 land development consultants  
 1126 VICTORIA AVENUE YORK, PA 17403  
 P 717.338.7629 WWW.LANDWORKS-CIVIL.COM

PREPARED BY: LANDWORKS CIVIL DESIGN, LLC  
 DATE: 10/20/2023  
 PROJECT: GREINER TRACT  
 SHEET: CS-101



PROJ. MGR.	J.B.
DESIGN	T.B.F.
CADD	T.B.F.
CHECKED	J.B.

REV.	
NO.	DATE

**LANDWORKS CIVIL DESIGN, LLC**  
 Land Development Consultants  
 1105 MARKET AVENUE, SUITE 201  
 P.O. BOX 10101, HAVERTY, PA 19308  

LANDSCAPING PLAN  
 FOR  
**283 COMMERCE CENTER - BUILDING #1**  
 FOR  
 PDC NORTH EAST LP IV, LLC  
 MOUNT JOY TOWNSHIP  
 LANCASTER COUNTY, PENNSYLVANIA

PROJECT NO. 22-0123-005  
 DATE: 09/22  
 SCALE: 1" = 50'  
 SHEET **C-802**

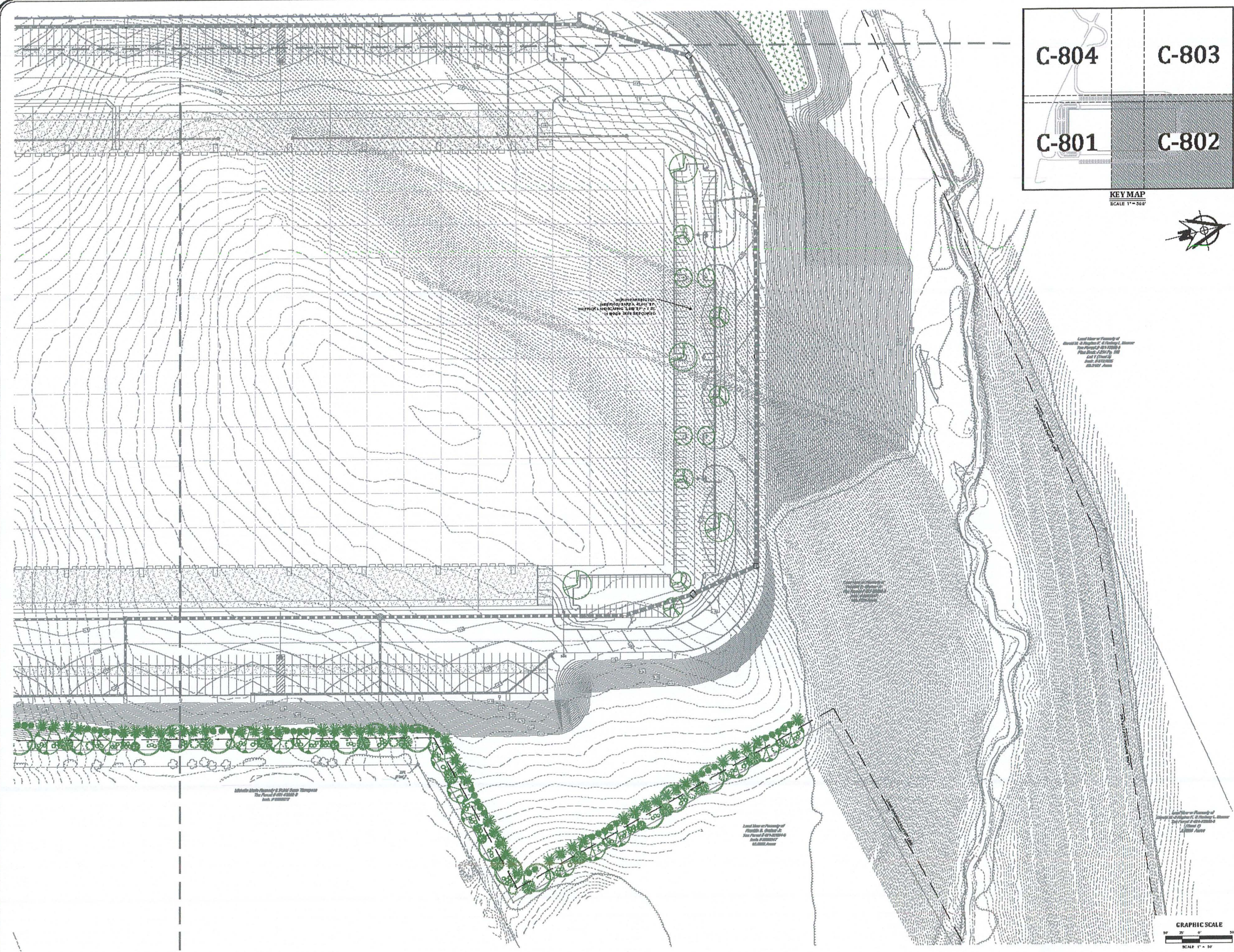
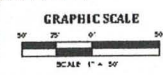
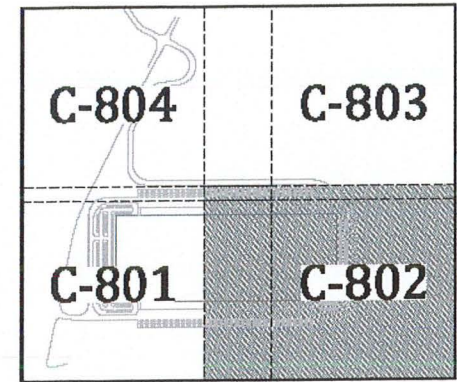

LANDSCAPING PLAN  
 FOR  
**283 COMMERCE CENTER - BUILDING #1**  
 FOR  
 PDC NORTH EAST LP IV, LLC  
 MOUNT JOY TOWNSHIP  
 LANCASTER COUNTY, PENNSYLVANIA

LANDSCAPING PLAN  
 FOR  
**283 COMMERCE CENTER - BUILDING #1**  
 FOR  
 PDC NORTH EAST LP IV, LLC  
 MOUNT JOY TOWNSHIP  
 LANCASTER COUNTY, PENNSYLVANIA

LANDSCAPING PLAN  
 FOR  
**283 COMMERCE CENTER - BUILDING #1**  
 FOR  
 PDC NORTH EAST LP IV, LLC  
 MOUNT JOY TOWNSHIP  
 LANCASTER COUNTY, PENNSYLVANIA

LANDSCAPING PLAN  
 FOR  
**283 COMMERCE CENTER - BUILDING #1**  
 FOR  
 PDC NORTH EAST LP IV, LLC  
 MOUNT JOY TOWNSHIP  
 LANCASTER COUNTY, PENNSYLVANIA

LANDSCAPING PLAN  
 FOR  
**283 COMMERCE CENTER - BUILDING #1**  
 FOR  
 PDC NORTH EAST LP IV, LLC  
 MOUNT JOY TOWNSHIP  
 LANCASTER COUNTY, PENNSYLVANIA

LANDSCAPING PLAN  
 FOR  
**283 COMMERCE CENTER - BUILDING #1**  
 FOR  
 PDC NORTH EAST LP IV, LLC  
 MOUNT JOY TOWNSHIP  
 LANCASTER COUNTY, PENNSYLVANIA

LANDSCAPING PLAN  
 FOR  
**283 COMMERCE CENTER - BUILDING #1**  
 FOR  
 PDC NORTH EAST LP IV, LLC  
 MOUNT JOY TOWNSHIP  
 LANCASTER COUNTY, PENNSYLVANIA

LANDSCAPING PLAN  
 FOR  
**283 COMMERCE CENTER - BUILDING #1**  
 FOR  
 PDC NORTH EAST LP IV, LLC  
 MOUNT JOY TOWNSHIP  
 LANCASTER COUNTY, PENNSYLVANIA

PROJ: 22-0123-005  
 DATE: 08/23/23  
 SCALE: 1"=50'  
 SHEET: C-803

PROJ: 22-0123-005  
 DATE: 08/23/23  
 SCALE: 1"=50'  
 SHEET: C-803

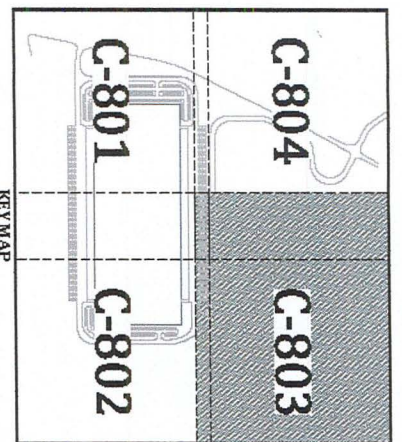
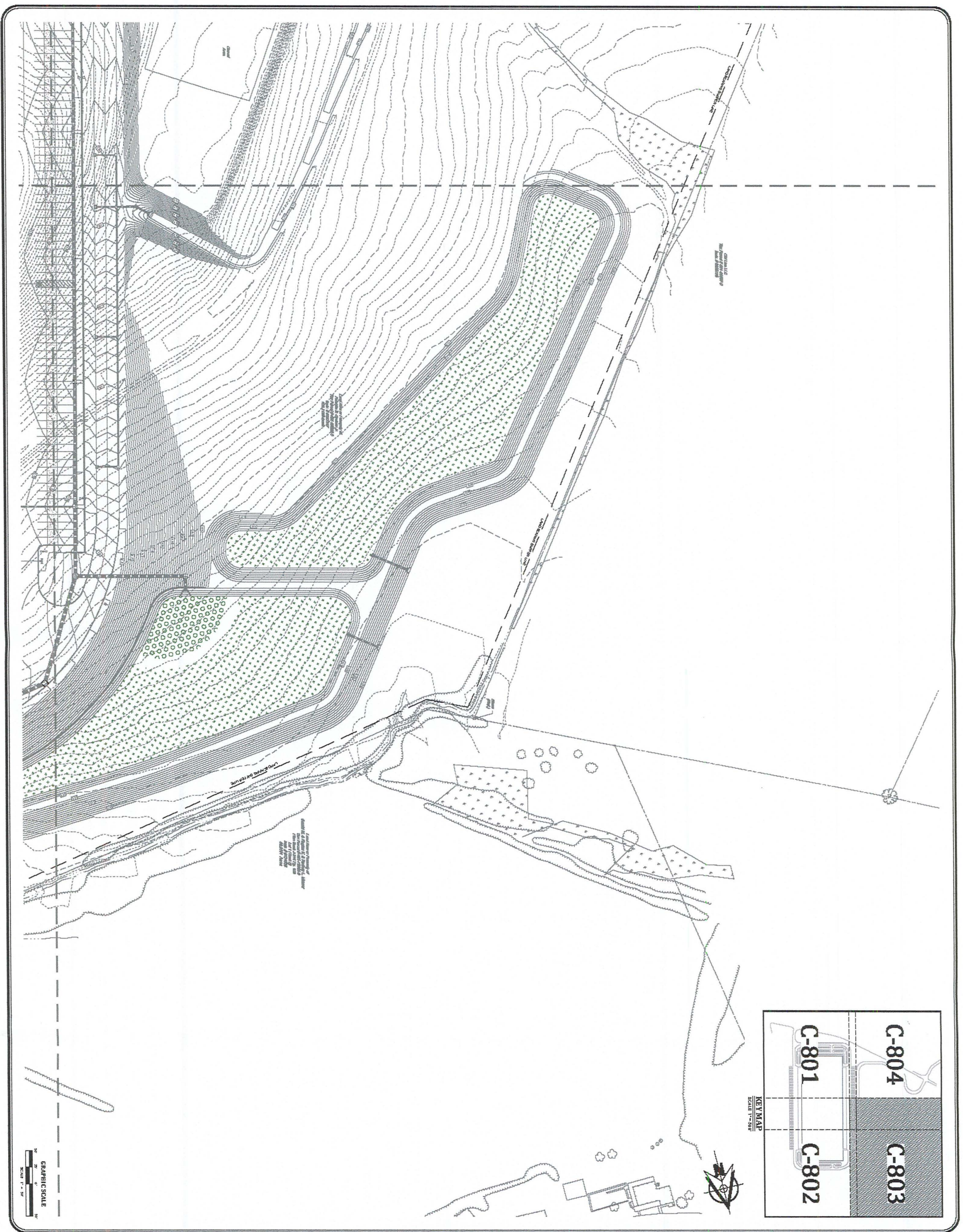

GRAPHIC SCALE  
 1" = 50'

PROJECT NO.  
 22-0123-005  
 DATE: 08/23/23  
 SCALE: 1"=50'  
 SHEET  
**C-803**

LANDSCAPING PLAN  
 FOR  
**283 COMMERCE CENTER - BUILDING #1**  
 FOR  
**PDC NORTHEAST LPV, LLC**  
 MOUNT JOY TOWNSHIP LANCASTER COUNTY, PENNSYLVANIA

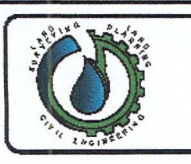

**LANDWORKS CIVIL DESIGN, LLC**  
*land development specialists*  
 1185 VIRGINIA AVENUE YORK, PA 17405  
 P 717.851.1155 www.landworksfor.com

NO.	DATE	REVISION

PROJ. NO. - JMS  
 DESIGN - TBE  
 CAD - TBE  
 CHECKED - JMS

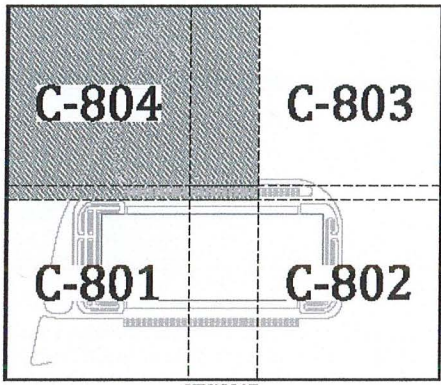

KEY MAP  
SCALE 1" = 500'



**PLANTING SCHEDULE**

SYMBOL	KEY	QTY	SCIENTIFIC NAME	COMMON NAME	SIZE & ROOT	SPACING
①	AND	15	ACHILLEA MILEFOLIUM	YACHT BUSH	2 1/2" CH. 8.50	AS SHOWN
②	AS	28	ACER SACCABINUM GREEN MOULIN	GREEN MOULIN	2 1/2" CH. 8.50	AS SHOWN
③	BN	38	BETULA NIGRA	BLACK BIRCH	2 1/2" CH. 8.50	AS SHOWN
④	CA	38	CLETHRA ALIFOLIA	BURNING BUSH	3" HI 5 GAL. CONT.	5' O.C.
⑤	CC	11	CARYOPHTERIS	PASADENA CEDAR	1 1/2" CH. 8.50	AS SHOWN
⑥	CE	12	CRATAEGUS CRUCIATA 'NINEHART'	THORN HORN	1 1/2" CH. 8.50	AS SHOWN
⑦	EV	35	EUONYMUS VITIFOLIA	COMMON WITCH HAZEL	3" HI 5 GAL. CONT.	5' O.C.
⑧	FF	38	FRAXINUS	GREEN BIRCH	2 1/2" CH. 8.50	AS SHOWN
⑨	GA	34	GEOPYETUM VITIFOLIA	PASADENA CEDAR	2" HI 5 GAL. CONT.	5' O.C.
⑩	IB	12	INDIGOFERA	INDIGO BUSH	3" HI 5 GAL. CONT.	5' O.C.
⑪	LI	18	LIRIODENDRON FLORIDANUM	FLORIDANUM	2 1/2" CH. 8.50	AS SHOWN
⑫	LO	18	LOPEROSUM	LOPEROSUM	3" HI 5 GAL. CONT.	5' O.C.
⑬	PS	25	PRUNUS SEROTINA	PASADENA CEDAR	2" HI 5 GAL. CONT.	5' O.C.
⑭	SC	35	SORBUS DOMESTICA	SCARLETT OAK	2 1/2" CH. 8.50	AS SHOWN
⑮	VE	38	VIBURNUM	PASADENA CEDAR	2" HI 5 GAL. CONT.	5' O.C.

- NOTES**
- SCALE 1:200 FOR PLANTING SCHEDULE. TO FULLY DEVELOP, CONSULT WITH ARCHITECT AND ENGINEER TO DETERMINE PLANTING SCHEDULE.
  - MINIMUM SPACING AS INDICATED BY THE SCHEDULE.
  - COORDINATES SHALL HAVE A CLEARANCE AT LEAST 5' ABOVE FINISHED GRADE.

**SEEDING SCHEDULE**

**LANDSCAPE PERIMETER SEEDING** - AREA TO BE SEED WITH PERENNIALS AND ANNUALS AT A RATE OF 20 LBS PER 1000 SQ FT. FERTILIZER TO BE APPLIED AT A RATE OF 10 LBS PER 1000 SQ FT.

**FORESET SEEDING** - AREA TO BE SEED WITH PERENNIALS AND ANNUALS AT A RATE OF 20 LBS PER 1000 SQ FT. FERTILIZER TO BE APPLIED AT A RATE OF 10 LBS PER 1000 SQ FT.

**WATER FEATURE SEEDING** - AREA TO BE SEED WITH PERENNIALS AND ANNUALS AT A RATE OF 20 LBS PER 1000 SQ FT. FERTILIZER TO BE APPLIED AT A RATE OF 10 LBS PER 1000 SQ FT.

**LANDSCAPING REQUIREMENTS**

**PARKING LOT**

**REQUIRED** (1) 25' X 10' (2) IN ANY PARKING AREA CONTAINING 15 OR MORE PARKING SPACES (EXCEPT A PARKING GARAGE), 3% OF THE TOTAL AREA OF THE PARKING LOT SHALL BE DEVOTED TO INTERIOR LANDSCAPING. SUCH INTERIOR LANDSCAPING MAY BE EITHER:

- AT THE END OF PARKING SPACE ROWS AND TO BREAK UP ROWS OF PARKING SPACES AT LEAST EVERY 15 PARKING SPACES, AND TO HELP VISUALLY DEFINE TRAVEL LANE THROUGH OR NEXT TO THE PARKING LOT. LANDSCAPING AREAS SITUATED OUTSIDE THE PARKING LOT SUCH AS PERIPHERAL AREAS AND AREAS SURROUNDING BUILDINGS SHALL NOT CONSTITUTE INTERIOR LANDSCAPING. FOR THE PURPOSE OF COMPUTING THE TOTAL AREA OF ANY PARKING LOT, ALL AREAS WITHIN THE PERIMETER OF THE PARKING LOT SHALL BE COUNTED, INCLUDING ALL PARKING SPACES AND ACCESS DRIVES, AISLES, ISLANDS AND CURVED AREAS. GROUND COVER IS NOT SUFFICIENT TO MEET THIS REQUIREMENT.
- TREES, SHRUBS OR OTHER APPROVED MATERIALS SHALL BE PROVIDED AT LEAST ONE SHADE TREE SHALL BE PROVIDED FOR EACH 250 SQUARE FEET OF PARKING LOT OF REQUIRED INTERIOR LANDSCAPING AREA. THESE TREES SHALL HAVE A CLEAR TRUNK AT LEAST FIVE FEET ABOVE FINISHED GRADE LEVEL.

**PROPOSED** SOUTH PARKING LOT 32 TREES  
NORTH PARKING LOT 14 TREES

**BUFFER YARD / SCREENING**

**REQUIRED** (1) 25' X 10' (2) RESIDENTIAL BUFFER STRIPS: WHEN AN INDUSTRIAL USE IS LOCATED ADJOINING A RESIDENTIAL DISTRICT OR A LOT THAT IS AVAILABLE FOR RESIDENTIAL USE, THE REQUIRED YARDS THAT SHARE SAID BOUNDARY SHALL CONTAIN A RESIDENTIAL BUFFER STRIP CONSISTING OF A MIX OF EVERGREEN AND DECIDUOUS TREES TO SCREEN BUILDINGS OFF STREET FRONTAGE AND LOADING AREAS FROM VIEW. THE LANDSCAPING SHALL BE PLANTED IN A MINIMUM OF TWO STAGGERED ROWS FOR A MORE EFFECTIVE SCREENING EFFECT. THE SPACING OF THE TREES SHALL BE NOT MORE THAN ONE HALF THE MATURE HEIGHTS OF THE TREES. NO FEWER THAN 60% OF THE TREES PLANTED SHALL BE EVERGREEN PLANTINGS. THE MINIMUM HEIGHT OF THE TREES AT THE TIME OF PLANTING SHALL BE FIVE FEET AND THE MINIMUM CALIPER OF TREES AT THE TIME OF PLANTING SHALL BE TWO AND A HALF INCHES.

(3) 25' X 10' (2) 5' HGT. REQUIRED LANDSCAPING STRIPS: INTERIOR LANDSCAPING SHALL INCLUDE A COMBINATION OF THE FOLLOWING ELEMENTS: DECIDUOUS TREES, GROUND COVERS IN EVERGREENS, SHRUBS, VINES, FLOWERS, ROCK, GRASS, BIRTH MOUNDS, FENCES, WALLS, SCREENS, SCULPTURES, FOUNTAINS, BORNIA PLANTINGS, OR OTHER APPROVED MATERIALS. ARTIFICIAL PLANTS, TREES, AND SHRUBS MAY NOT BE USED TO SATISFY ANY REQUIREMENT FOR LANDSCAPING OR SCREENING NO LESS THAN 80% OF THE REQUIRED LANDSCAPING AREA SHALL BE EITHER THE IN COMPLETION AND NO OUTDOOR SIGNAGE SHALL BE PERMITTED WITHIN REQUIRED LANDSCAPE AREAS.

(3) 25' X 10' (2) 3' FOR EVERY 750 SQUARE FEET OF REQUIRED LANDSCAPE STRIP, ONE SHADY TREE SHALL BE PROVIDED BY THE LANDSCAPE ARCHITECT. THESE TREES SHALL BE PLANTED AT LEAST FIVE FEET ABOVE FINISHED GRADE. IF EVERGREEN THESE TREES SHALL HAVE A MINIMUM HEIGHT OF SIX FEET. ALL REQUIRED LANDSCAPE STRIPS SHALL HAVE LANDSCAPING MATERIALS DISTRIBUTED ALONG THE ENTIRE LENGTH OF THE LOT LINE ADJUTING THE YARD. BUT SHALL NOT NECESSARILY BE REQUIRED TO HAVE A UNIFORM SEPARATION DISTANCE ALONG THE ENTIRE LENGTH OF THE LANDSCAPE STRIP.

**PROPOSED** EASTERN BUFFER PROPOSED PLANTINGS ON SHEETS C-801 & C-802  
NORTHERN BUFFER, EXISTING WOODLANDS

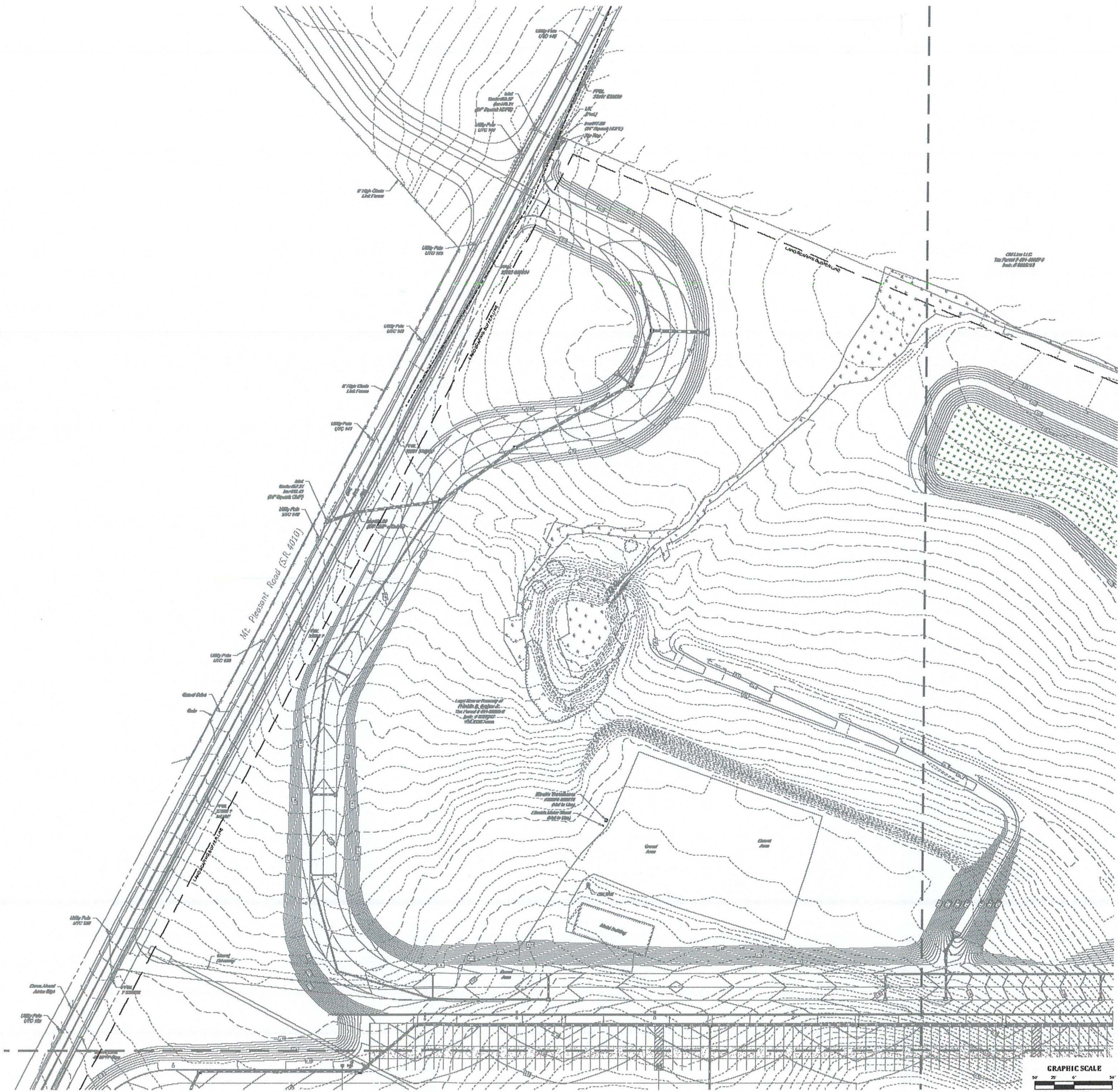

PROJ. MGR. - JLB  
DESIGN - TBF  
CADD - TBF  
CHECKED - JLB

NO.	DATE

**LANDWORKS CIVIL DESIGN, LLC**  
Civil Engineering & Construction

1100 WILMINGTON BLVD.  
SUITE 100  
LANCASTER, PA 17602



**LANDSCAPING PLAN**  
FOR  
**283 COMMERCE CENTER - BUILDING #1**  
FOR  
PDC NORTH EAST LPV, LLC

LANCASTER COUNTY, PENNSYLVANIA  
MOUNT JOY TOWNSHIP

PROJECT NO.  
22-0123-005  
DATE: 09/3/21  
SCALE: 1" = 50'  
SHEET  
**C-804**



C-904 C-903

C-901 C-902

KEY MAP  
SCALE 1"=50'



Mt. Pleasant Road (S.R. #10)

Stauffer Road

Stauffer Road



PROJ. MGR. JJB  
DESIGN. TBF  
CADD. TBF  
CHECKED. JJB

LANDWORKS  
CIVIL DESIGN, LLC  
Local Development Consultants  
1100 WILKESBARRE  
P.O. BOX 100  
WILKESBARRE, PA 18702  
www.landworksllc.com



LIGHTING PLAN  
FOR  
283 COMMERCE CENTER - BUILDING #1  
FOR  
POC NORTHEAST LPW, LLC  
MOUNT JOY TOWNSHIP  
LANCASTER COUNTY, PENNSYLVANIA

PROJECT NO.  
22-0123-005  
DATE: 01/03/23  
SCALE: 1"=50'  
SHEET  
C-901

Vertical text on the left margin containing project details and dates.



PROJ. MGR. -	JJB
DESIGN -	T&F
CADD -	T&F
CHECKED -	JJB

NO.	DATE

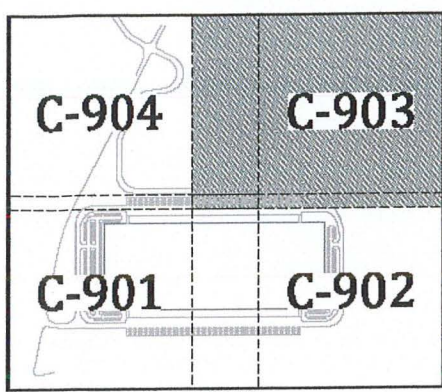

KEY MAP  
SCALE 1"=50'

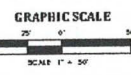
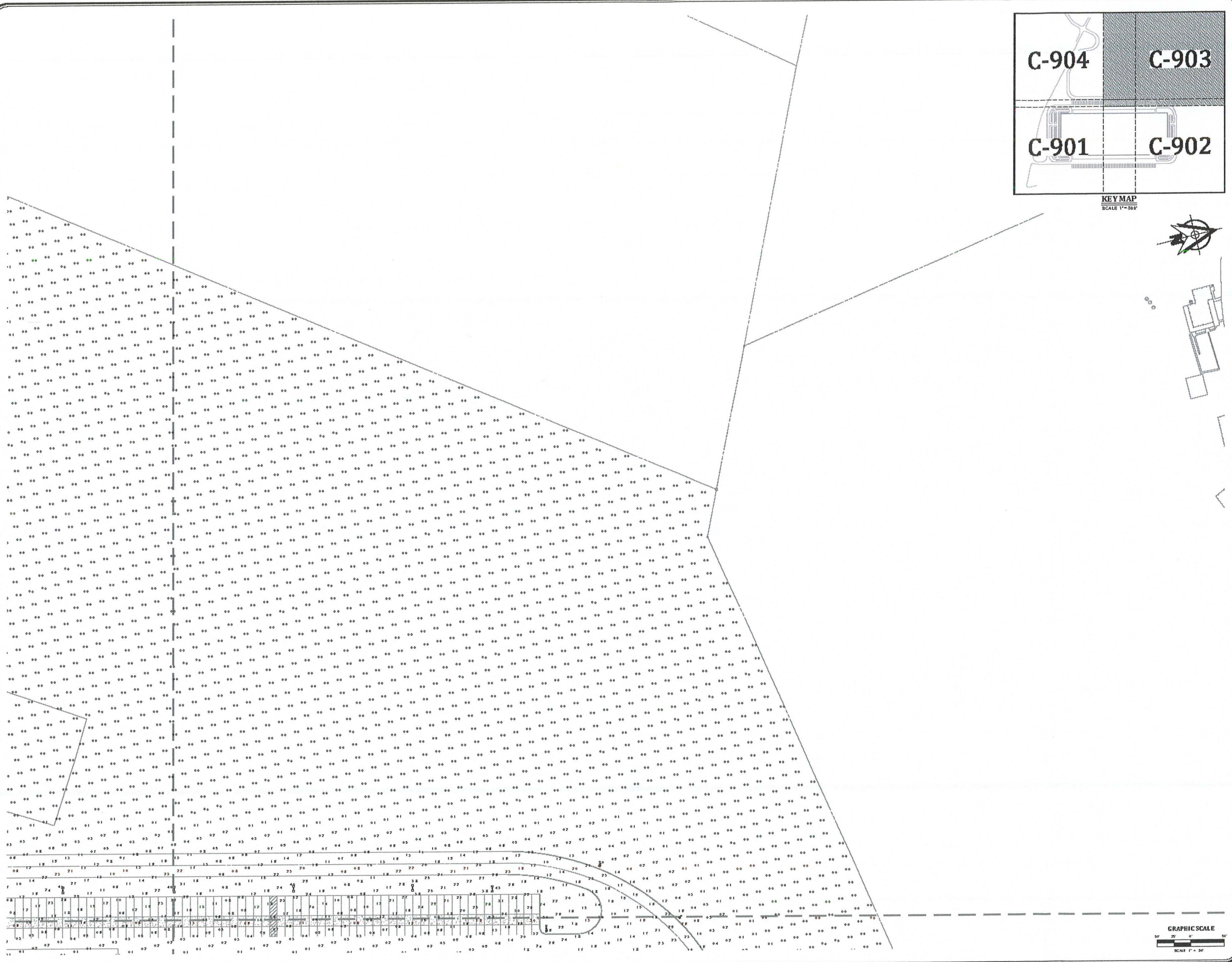
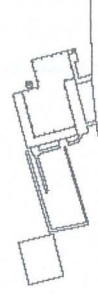

**LANDWORKS**  
CIVIL DESIGN, LLC  
*land development construction*

115 FREEDLANDS DRIVE  
MILLSBORO, DE 19966

2024.04.11.18  
www.landworksllc.com

LIGHTING PLAN  
FOR  
**283 COMMERCE CENTER - BUILDING #1**  
FOR  
PDC NORTHEAST LPW, LLC  
LANCASTER COUNTY, PENNSYLVANIA

PROJECT NO. 22-0122-005  
DATE: 01/03/23  
SCALE: 1"=50'  
SHEET  
**C-903**

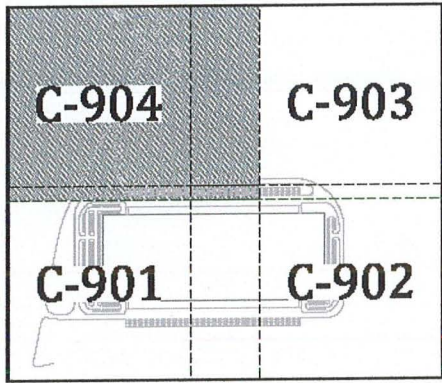

KEY MAP  
SCALE 1"=500'

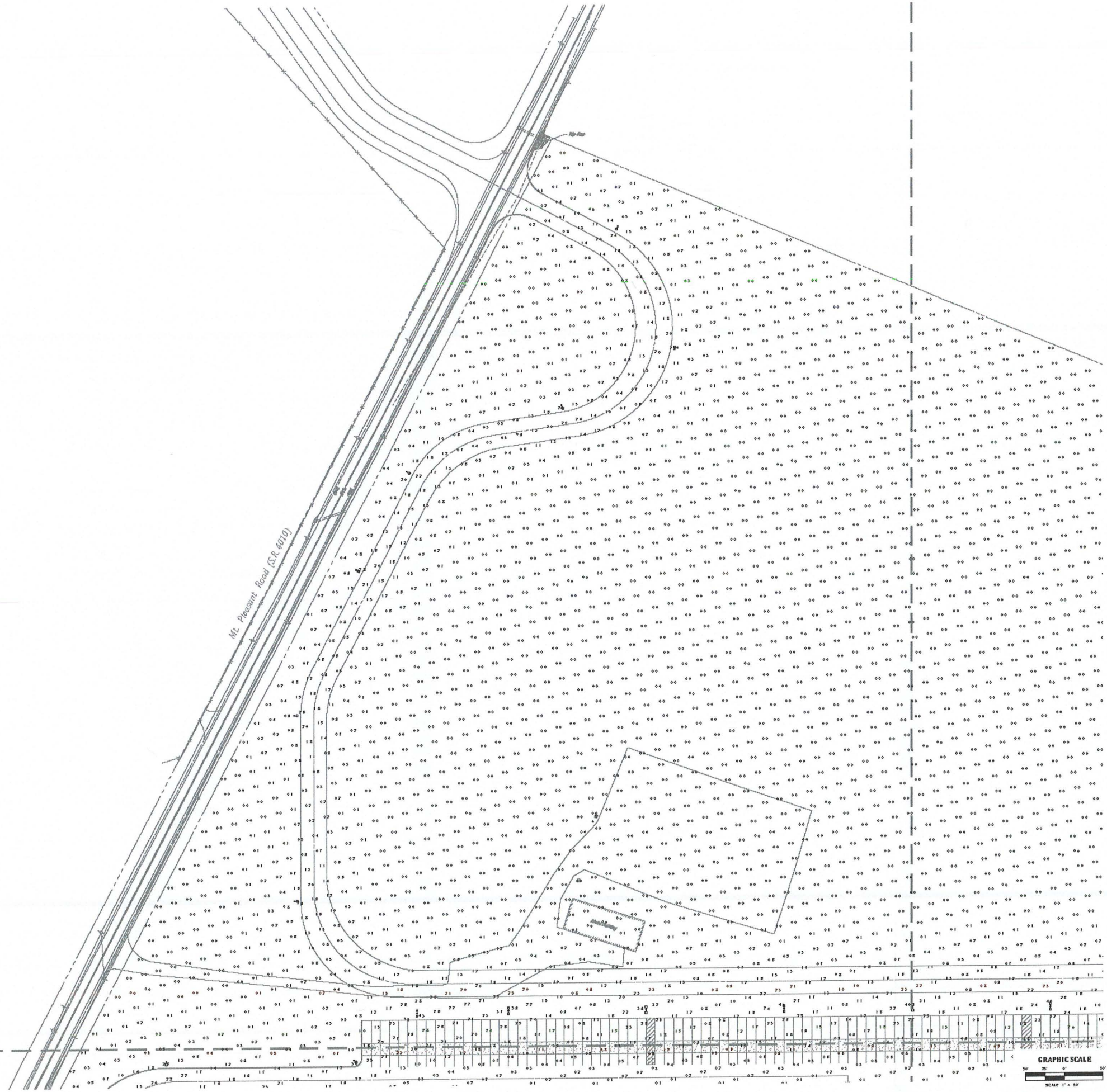

PROJ MOR - JJB  
DESIGN - TBF  
CADD - TBF  
CHECKED - JJB

NO.	DATE

**LANDWORKS**  
CIVIL DESIGN, LLC  
land development consultants  
115 WEST HERRING STREET  
P.O. BOX 881418  
MOUNTAIN VIEW, MO 64158  
TEL: 816.264.1100  
WWW.LANDWORKS-LLC.COM



LIGHTING PLAN  
FOR  
283 COMMERCE CENTER - BUILDING #1  
FOR  
POC NORTHEAST LPV, LLC  
MOUNT JOY TOWNSHIP  
LANCASTER COUNTY, PENNSYLVANIA

PROJECT NO. 22-0123-005  
DATE: 06/03/23  
SCALE: 1"=50'  
SHEET  
**C-904**

DATE: 06/03/23  
DRAWN BY: JJB  
CHECKED BY: TBF  
SCALE: 1"=50'

PROJECT NO. 22-0123-005  
SHEET C-904

### D-Series Size 2 LED Area Luminaire

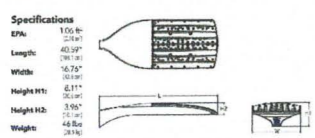

**Specifications**

EPN	100 ft
Length	40.35"
Width	16.75"
Height HT	2.11"
Height HD	1.50"
Weight	4.8 lbs

**Ordering Information**

EXAMPLE: DSX2 LED P7 40K 70CRI T3M MVOLT SPA NLAIR2 PIRHN DOBXD

Code	Description	Code	Description
DSX2	Size 2 DSX2 LED	P7	40K 70CRI T3M MVOLT SPA NLAIR2 PIRHN DOBXD

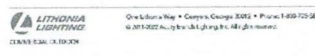

### WDGE3 LED Architectural Wall Sconce

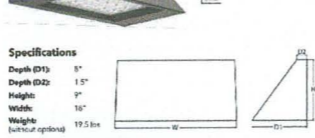

**Specifications**

Depth (D1)	1.5"
Depth (D2)	1.5"
Height	9"
Width	18"
Weight (fixture optional)	17.5 lbs

**Ordering Information**

EXAMPLE: WDGE3 LED P3 40K 70CRI R3 MVOLT SRM DOBXD

Code	Description	Code	Description
WDGE3	Size 3 WDGE3 LED	P3	40K 70CRI R3 MVOLT SRM DOBXD



### LIGHTING SCHEDULE

SYMBOL	LABEL	QTY	DESCRIPTION	LLF	MOUNTING HEIGHT (AFO)
□	AFT	2	DSX2 LED P7 40K 70CRI T3M MVOLT SPA NLAIR2 PIRHN DOBXD FULL CUTOFF AREA LIGHT W/ FORWARD THROW DISTRIBUTION (POLE MOUNTED)	0.900	30 FT
□	OFT	2	WDGE3 LED P3 40K 70CRI R3 MVOLT SRM DOBXD FULL CUTOFF WALL PACK W/ FORWARD THROW DISTRIBUTION (WALL MOUNTED)	0.900	30 FT

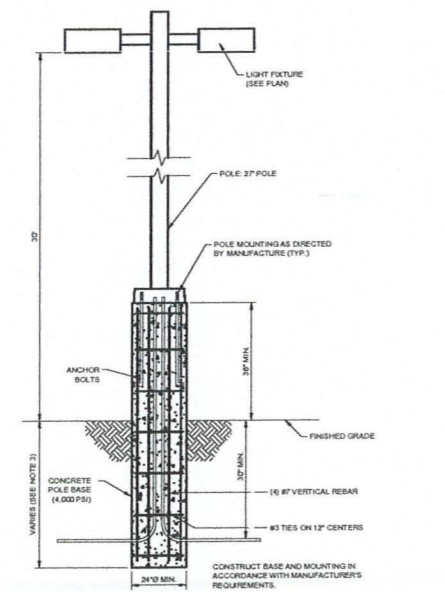

**NOTE:**

- SEE ELECTRICAL DRAWINGS FOR CONDUIT LOCATIONS.
- NUMBER AND SIZE OF ANCHOR BOLTS PER MANUFACTURER'S REQUIREMENTS.
- FOUNDATION DIMENSION AND DESIGN TO BE PROVIDED BY THE LIGHTING DESIGNER.
- CONCRETE FOUNDATION TO BE PLACED A MINIMUM OF 12' BEHIND TRAILER PARKING LOTS AND A MINIMUM OF 8' BEHIND CAR PARKING LOTS (MEASURED FROM BACK OF CURB TO CENTER OF CONCRETE FOUNDATION).

**LIGHT STANDARD-RAISED MOUNT**

NOT TO SCALE

NO.	DATE	REVISION

**LANDWORKS CIVIL DESIGN, LLC**  
land development consultants

1100 WILCOX AVENUE  
P.O. BOX 15106  
LANCASTER COUNTY, PENNSYLVANIA

LANDWORKS CIVIL DESIGN, LLC  
LAND DEVELOPMENT CONSULTANTS

FOR  
**283 COMMERCE CENTER - BUILDING #1**  
FOR  
PDC NORTHEAST LPW, LLC

LANCASTER COUNTY, PENNSYLVANIA  
MOUNT JOY TOWNSHIP

PROJECT NO. 22-0123-005  
DATE: 01/03/23  
SCALE: 1" = 60'  
SHEET  
**C-905**



# LANDWORKS CIVIL DESIGN, LLC

www.landworkscd.com

January 4, 2023

Mount Joy Township  
8853 Elizabethtown Road  
Elizabethtown, PA 17022

Re: Special Exception Report  
283 Commerce Center – PDC Northeast LPIV, LLC  
Mount Joy Township, Lancaster County, PA

Dear Board Members:

The purpose of this Special Exception Report is to further supplement the Zoning Hearing Board Application prepared by McNees Wallace & Nurick LLC, as it pertains to the proposed improvement of the subject parcel (PID #461-89922-0). More specifically, the purpose of this supplement is to demonstrate compliance with the applicable requirements of Articles 23 of the Mount Joy Township Zoning Ordinance (the "Zoning Ordinance") pertaining to General Regulation of environmentally sensitive areas (sections 135-304 – 135-307).

Panattoni Development Company, by way of a special purpose entity PDC Northeast LPIV, LLC ("PDC"), is the equitable owner of partially developed land located at 2843 Mount Pleasant Road (the "Property") in Mount Joy Township (the "Township"), Lancaster County, Pennsylvania. PDC is a full-service real estate investment, development, and management company with management responsibilities for industrial development projects, including warehousing / distribution facilities, located in Pennsylvania and across the United States. PDC has an agreement with the owner of the Property, Franklin B. Greiner Jr., to purchase and develop the Property, which is approximately 106.3125 acres, as warehouse / distribution facility ("Facility"). As depicted on the Conceptual Site Plan, the proposal before the Township Zoning Hearing Board for the Facility includes one (1) Class A "cross-docked" warehouse building (the "Building") totaling approximately 1,006,880 square feet. The Facility also includes truck courts, passenger vehicle parking areas, access roads, utility systems and related site improvements. In the future, PDC might pursue separate approvals for a second warehouse building, but that building is not part of this application.

## **§135-304 Mature Forest and Woodland Preservation Operations & Environmental Impacts**

- A. Mature forests and woodland preservation requirements. The purpose of the regulations of this section are to preserve mature forest and woodland areas which are essential elements of the local green infrastructure, and remaining locations of these prime woodlands should be conserved for future generations. These areas provide the highest quality habitat for native plant and animal species, provide natural beauty, facilitate groundwater recharge, slow runoff, and stabilize soils from erosion.**

1195 Virginia Avenue, York, PA 17403

Camp Hill, PA  
(717) 579-0074

York, PA  
(717) 891-1195

The standards contained in this section are intended to maintain large areas of woodlands, especially those insulated from clearing and other impacts. Properties in the A, CR, and R Zoning Districts which contain mature forest and woodlands shall comply with the following regulations.

- (1) At least 60% of areas defined as a mature forest or woodland area on a tract of land shall be retained as mature forest or woodland. Any land disturbances within a mature forest or woodland area shall occur as close as possible to a property line and/or the outer edges of the mature forest or woodland area in order to maintain the integrity of the continuous mature forest or woodland area.
- (2) If in the event a landowner and/or developer demonstrates that the above preservation requirement is too substantial and would prevent a property from being developed with a use permitted by right or by special exception in the zoning district in which the property is located in and in strict compliance with any other Township, state or federal regulation, then the applicant may seek a special exception to reduce the preservation area below the required 60%, so that the development may occur within applicable Township, state or federal regulations. It shall be the landowner or applicant's responsibility to demonstrate that the minimum reduction to the preservation requirements is being requested in order to prevent unnecessary tree removal.
- (3) Any subdivision plan, land development plan, or zoning permit application proposing the removal of any trees shall clearly illustrate the area of mature forest or woodland area that will be removed and the methods that will be utilized by the landowner and/or developer to ensure that the amount of tree removal will not create a violation of Subsection A(1) or A(2) above.

The subject parcel (PID #461-89922-0) is in the Township's Light Industrial zoning district. As such, section 135-304 does not apply. Nonetheless, the proposed improvements have been strategically designed to preserve as much mature forest and woodland as reasonably practical while simultaneously addressing the market demand for an industrial building which provide users with a modern, high-bay, cross-docked facility with full size truck courts. These market demands of building size between 1 million and 1.3 million square feet continue to be routine for many Fortune 500 companies who are consolidating their operations to create efficiencies.

#### **§135-305 Steep Slope Regulations**

It is the purpose of these regulations to limit the amount of the removal of natural resources of the Township, protect the watershed areas from increased soil runoff which results in decreased water quality, and to prevent the loss of sensitive habitats and potential slope failures. This section shall not create liability on the part of Mount Joy Township or any officer or employee thereof for any damages that result from the reliance on this section or any administrative decision lawfully made hereunder.

- A. Steep slopes greater than 15% shall be shown on all subdivision or land development plans or in the case where a subdivision or land development plan is not required, on a required site plan to be submitted with a zoning permit application. A differentiation of slopes between 15% and 25% and those

greater than 25% shall be indicated on the plans. The Zoning Officer may require that the applicant submit a topographical survey prepared by an individual registered in the Commonwealth of Pennsylvania to prepare such surveys which shall show the degree of slope.

Acknowledged. The subdivision and land development plan for the facility shows steep slopes that are greater than 15%, as required by this Section. In addition, an exhibit depicting the existing steep slope areas is provided herein as "Steep Slope Exhibit".

- B. If more than 50% of the minimum required lot area is on slopes which exceed 20%, a minimum lot area of 40,000 square feet is required for each principal building to be constructed.**

Less than 50% of the minimum required lot area of the subject parcel (PID #461-89922-0) is on slope which exceed 20%. As such, section 135-305.B. does not apply.

- C. Any disturbance of steep slopes shall be completed within one construction season, and disturbed areas shall not be left bare and exposed during the winter and spring thaw periods. Permanent vegetative cover shall be planted within three days after completion of grading.**

Acknowledged. In addition, all disturbance required to construct the proposed improvements will be covered under a National Pollutant Discharge Elimination System (NPDES) permit which requires the stabilization of all disturbed areas to prevent accelerated soil erosion.

**D. Grading requirements.**

- (1) Grading and earthmoving on all steep slopes shall not result in earth cuts or fills whose highest vertical dimensions exceed 10 feet, except if one of the following applies:**

**(a) Where no reasonable alternatives exist for construction of roads, drainage structures, and other public improvements, earth cuts and fills' highest vertical dimensions shall not exceed 20 feet.**

**(b) The maximum vertical dimension of cuts or fills does not apply if an engineered retaining wall is constructed. The retaining wall shall be subject to review and approval under the Uniform Construction Code.**

- (2) Finished slopes of all cuts and fills shall not exceed 3:1, unless the applicant can satisfactorily demonstrate to the Zoning Officer that steeper slopes can be stabilized and maintained adequately. The Zoning Officer may consult with the Township Engineer if needed. The landscape shall be preserved in its natural state insofar as practicable.**

Acknowledged. The proposed improvements will result in earth cuts and fills of a vertical height greater than 10 feet. As such, an engineered retaining wall is proposed to satisfy section 135-305.D.1.(b). Full design drawings will be provided to the Township for review and approval by the Township Zoning Officer



and under the Uniform Construction Code prior to construction. Additionally, a geotechnical report will be provided to the Township for review to satisfy section 135-305.D.2. as it pertains to any areas of the proposed improvements that require a cut slope greater than 3:1.

- E. Any fill placed on a lot shall be properly stabilized and, when found necessary depending upon existing slopes and soil types, supported by retaining walls or other appropriate structures as approved by the Township Zoning Officer. The Zoning Officer may consult with the Township Engineer if needed. Any retaining walls shall meet the standards of the Pennsylvania Uniform Construction Code.**

Acknowledged. All disturbance required to construct the proposed improvements will be covered under a National Pollutant Discharge Elimination System (NPDES) permit which requires the stabilization of all disturbed areas to prevent accelerated soil erosion. Additionally, full design drawings for any proposed retaining wall will be provided to the Township for review and approval by the Township Zoning Officer and under the Uniform Construction Code prior to construction.

- F. Any cuts shall be supported by retaining walls or other appropriate retaining structures, when, depending upon the nature of the soil characteristics, such structures are required in order to prevent erosion and are approved by the Township Zoning Officer. The Zoning Officer may consult with the Township Engineer if needed.**

Acknowledged. The proposed improvements include engineered retaining walls to satisfy section 135-305.D.1.(b). Full design drawings will be provided to the Township for review and approval by the Township Zoning Officer and under the Uniform Construction Code prior to construction.

#### **§135-306 Riparian Corridors and Setback Requirements from Waterways and Major Drainage Swales**

The intent of the regulations of this section is to reduce the amount of nutrients, sediment, organic matter, pesticides, and other harmful substances that reach water courses, floodplains, adjoining wetlands and subsurface and surface water bodies.

- A. Riparian corridors of 75 feet in width on each side of the Conewago or Little Chickies Creek, measured from the top of each stream bank, shall be maintained free of any buildings or structures. In the event of a dispute on the location of the top of the primary bank of the stream, the location of the top of the primary bank shall be determined by the Township Engineer.**

The subject parcel (PID #461-89922-0) does not have direct frontage along the Conewago or little Chickies Creek. As such, Section 135-306.A. does not apply.

- B. Riparian corridors of 30 feet on each side of any other stream or watercourse, measured from the top of each stream bank, shall be maintained free of any buildings or structures other than bridges, culverts, and other stormwater management facilities. As used in this section, "bridges and culverts" shall include the roadway approaches to such bridges and culverts. In the event of a dispute on the location**

**of the top of the primary bank of the stream or watercourse, the location of the top of the primary bank shall be determined by the Township Engineer.**

No disturbance is proposed within 30 feet of the on-site streams. As such, the Application complies with Section 135-306.B.

- C. Riparian corridors shall be extended to encompass, at a minimum, the entire one-hundred-year floodplain. If a delineated wetland is located adjacent to the riparian corridor, the entire wetland area shall be included with the riparian corridor and shall be subject to all standards for wetlands in this chapter.**

No disturbance is proposed within the assumed 50 foot one-hundred-year floodplain of any on-site streams or within any on-site wetland for the Facility. As such, the Application complies with Section 135-306.C.

- D. The following performance standards shall apply to riparian corridors:**

- (1) Existing vegetated areas within the riparian corridor shall be preserved to the maximum extent possible.**
- (2) The planting of additional native trees, shrubs and other plant material and the removal of invasive species as determined necessary in order to create a suitable riparian canopy and understory within the riparian corridor shall be permitted.**
- (3) Septic drain fields and sewage disposal systems shall not be permitted within the riparian corridor and shall maintain a minimum distance of 100 feet from the top of a stream bank.**
- (4) Solid waste disposal facilities, mining operations and junkyards shall not be permitted within 300 feet of the top of a stream bank.**
- (5) Above or underground petroleum storage facilities shall not be permitted within 150 feet of the top of a stream bank.**
- (6) The application for biosolids shall not be permitted within 100 feet of the top of a stream bank.**
- (7) Storage and handling of any hazardous wastes must have impermeable surfaces designed to contain materials stored/handled from which they shall be directed to a predetermined collection point, which shall not be located within a riparian corridor.**
- (8) With the exception of the construction of pedestrian trails and associated observation decks or areas, waterway access, waterway restoration and enhancement, livestock crossings, and infrastructure and utility crossings, the filling, grading or excavating of riparian corridors, shall be prohibited.**

**(9) The grazing, housing or other maintenance of livestock within the riparian corridor shall be prohibited.**

No disturbance is proposed within the riparian areas of any on-site streams. Further, no prohibited items or activities described in sections 135-306.D.3 – 135-306-D.9 are anticipated. As such, the Application complies with Section 135-306.D.

**E. Major drainage swales. If an aboveground drainage swale is engineered to carry more than 25 cubic feet per second during a ten-year storm and is proposed to be placed within a required front, rear or side yard for a building, then the minimum width of such yard shall be 15 feet greater than the width that otherwise would be required.**

The project does not propose any aboveground drainage swales which carry more than 25 cubic feet per second during a then-year storm event within the front, rear, or side yards. As such, section 135-306.E. does not apply.

**F. The riparian corridor shall be placed within a conservation easement and any applicant for development of a lot which contains a riparian corridor shall enter into a recordable agreement with the Township providing for the permanent maintenance of the riparian corridor; such agreement shall be in a form acceptable to the Township Solicitor.**

Applicant proposes to place riparian corridors on the Property within a conservation easement as described in section 135-306.F. Applicant's attorney will work with the Township Solicitor to prepare a conservation easement that is acceptable to the Township Solicitor.

#### **§135-307 Wetlands**

**Wetlands are unique natural resources that serve multiple green infrastructure purposes, and should be conserved for their ecological functions and practical value. Their role in improving water quality, storing stormwater runoff, maintaining surface water flow, and providing habitat for flora and fauna are of high importance. The conservation of wetlands, as with riparian corridors, serves these purposes for the local community's benefit as well as the greater region that includes the Chesapeake Bay.**

**A. Wetlands shall not be altered, regraded, filled, piped, diverted, or built upon except where approvals have been obtained from the DEP and/or the United States Army Corps of Engineers.**

No disturbance of any on-site wetland is proposed. As such, the Application complies with Section 135-307.A.

**B. Required buffer.**

- (1) Purpose.** Buffers upland of an aquatic resource can, through various physical, chemical and biological processes, reduce impacts to wetlands from adjacent land uses. Buffers also provide the terrestrial habitats needed by many species of wildlife that use wetlands to meet some of their needs.
- (2) General requirement.** A twenty-five-foot buffer surrounding the wetlands boundary shall be conserved for naturally occurring vegetation or for the reestablishment of native plant species. The width of the buffer is measured along the horizontal plane.
- (3) Alternative standard.** In cases where the required twenty-five-foot buffer cannot be provided around the entire perimeter surrounding the wetlands boundary, the following shall apply:
  - (a)** The total required buffer area shall be calculated using a twenty-five-foot buffer surrounding the wetlands boundary. The total buffer area shall be measured in units of area along the horizontal plane.
  - (b)** The buffer may be reduced below 25 feet for a maximum of 25% of the perimeter of the wetlands boundary if the total buffer area provided is at least 110% of the total required buffer area calculated in Subsection B(3)(a). In no case shall the buffer be less than 15 feet.
  - (c)** If use of the alternative standard in this subsection is proposed, the developed area shall be designed to prevent polluted stormwater runoff from discharging into the wetlands in the area where the buffer is less than 25 feet wide.

No disturbance within 25 feet of any on-site wetland is proposed. As such, the Application provides at least a 25-foot buffer around any on-site wetlands such that the Application complies with Section 135-307.B.

- C. Septic drainfields and sewage disposal systems shall not be located within 100 feet of the wetlands boundary. The replacement of an existing sewage disposal system located within this setback line shall comply with the setbacks set forth herein.**

No septic drainfields or sewage disposal systems are proposed within 100 feet of the wetland boundaries. As such, the Application complies with Section 135-307.C.

- D. The applications of biosolids shall not occur within the wetlands or within 100 feet of the wetlands boundary.**

No application of biosolids is proposed within 100 feet of the wetland boundaries. As such, the Application complies with Section 135-307.D.

- E. All wetland locations shall be placed within a conservation easement and any applicant for development of a lot which contains delineated wetlands shall enter into a recordable agreement with the Township providing for the permanent maintenance of the wetland area; such agreement shall be in a form acceptable to the Township Solicitor.**

Applicant proposes to place wetland locations on the Property within a conservation easement as described in section 135-307.E. Applicant's attorney will work with the Township Solicitor to prepare a conservation easement that is acceptable to the Township Solicitor.

*Prepared by Jeremy Bittinger, E.I.T.*

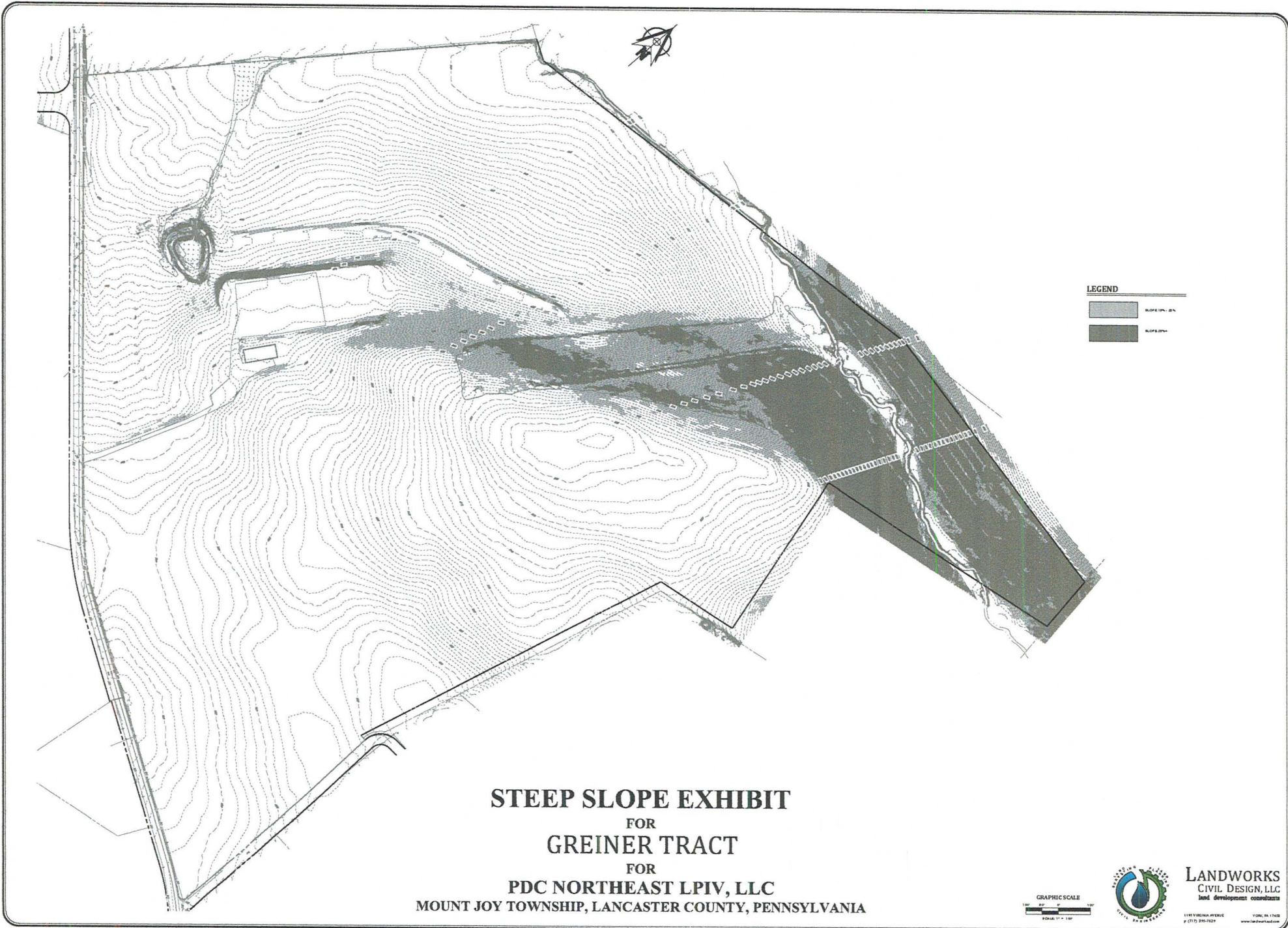

**STEEP SLOPE EXHIBIT**  
FOR  
**GREINER TRACT**  
FOR  
**PDC NORTHEAST LPIV, LLC**  
**MOUNT JOY TOWNSHIP, LANCASTER COUNTY, PENNSYLVANIA**

**LEGEND**

	SLOPE 10%
	SLOPE 20%



**LANDWORKS**  
CIVIL DESIGN, LLC  
land development consultants

119 VIRGINIA AVENUE YORK, PA 17403  
P. 717.336.1827 www.landworksllc.com



 **PROVIDENCE**  
ENGINEERING

 **PANATTONI**<sup>®</sup>

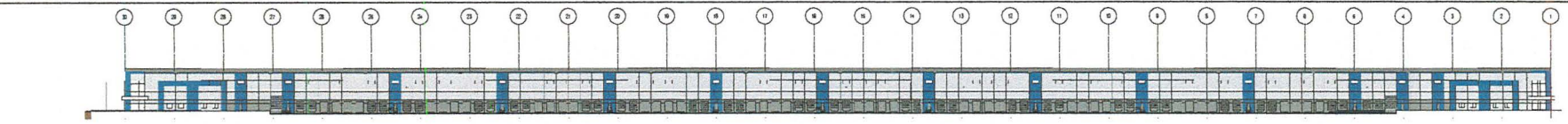

OVERALL SOUTH ELEVATION  
SCALE: 1/4" = 1'-0"

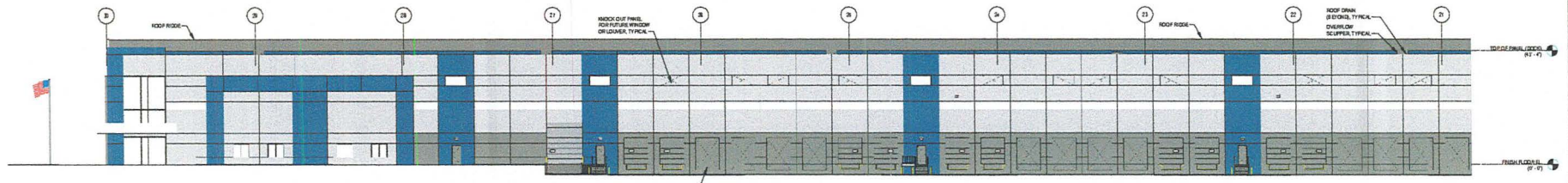

ENLARGED SOUTH ELEVATION - AREA A  
SCALE: 1/8" = 1'-0"

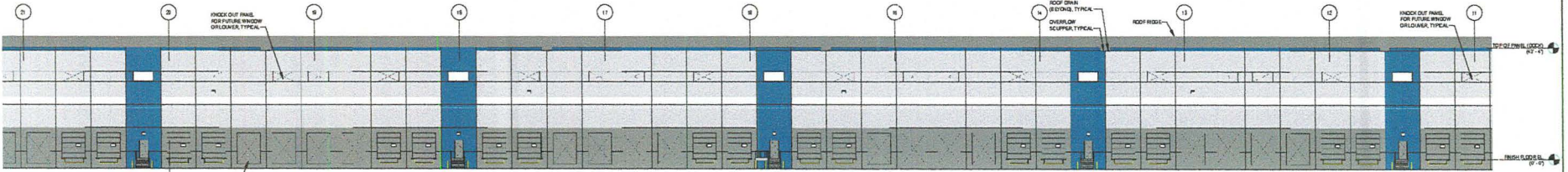

ENLARGED SOUTH ELEVATION - AREA B  
SCALE: 1/8" = 1'-0"

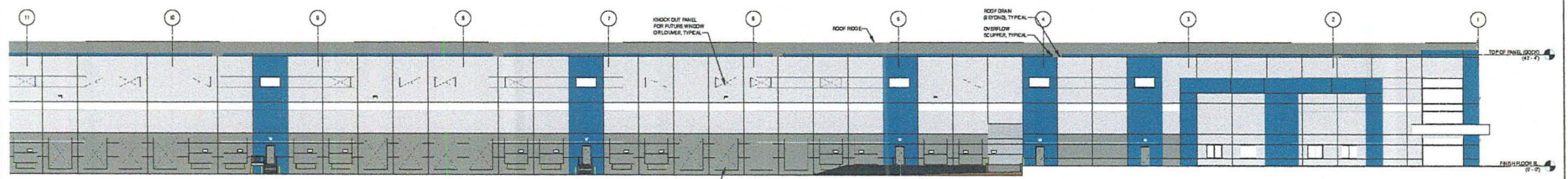

ENLARGED SOUTH ELEVATION - AREA C  
SCALE: 1/8" = 1'-0"

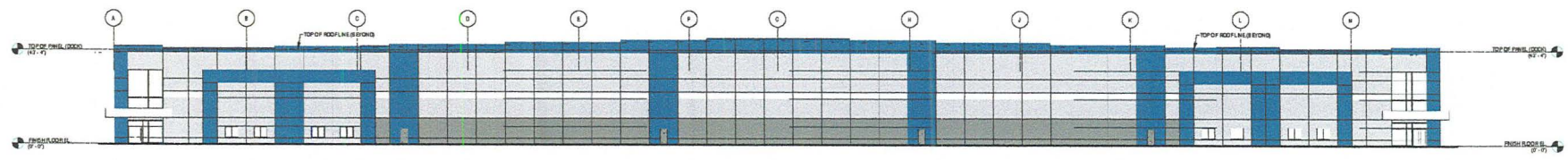

OVERALL WEST ELEVATION  
SCALE: 1/4" = 1'-0"

**PROVIDENCE**  
ENGINEERING GROUP

1100-316000  
1000 S. 1ST ST  
LANTCASTER, PA 17322  
TEL: 717-244-4444  
WWW.PROVIDENCE-ENG.COM

DATE	BY
REVISION	

**PANATTONI**  
ARCHITECTS  
HARTFORD, PA 17112

**SOUTH AND WEST ELEVATIONS**  
**MOUNT JOY**  
LANCASTER COUNTY, PA

DRAWN BY:	GDG
CHECKED BY:	JAH/BAP
DATE:	
SCALE:	AS INDICATED
JOB NO.:	222801
SHEET:	B202
REVISION:	



**PROPOSED CONDITIONS FOR  
SPECIAL EXCEPTION APPLICATION**

1. Landowner Franklin B. Greiner (“Landowner”) shall enter into an Agreement Providing for Grant of Conservation Easement in a form acceptable to the Township Solicitor to preserve and protect the floodplain and wetlands areas at the northern and western portions of the tract identified as Lancaster County Tax Account No. 461-89922-0-0000 which is the subject of the application (the “Property”). Such Agreement Providing for Grant of Conservation Easement may allow some changes to the wetlands in the area of the pond if authorized by the Pennsylvania Department of Environmental Protection or the Army Corps of Engineers if a second building is developed on the Property.

2. Applicant shall construct a roadway across the property of Landowner identified as Lancaster County Tax Account No. 461-15379-0-0000 to connect Steel Way Drive to Mount Pleasant Road described as the “extension of Steel Way” in the letter from Applicant’s consultant Traffic Planning and Design, Inc. (“TPD”) dated December 22, 2022 (the “Steel Way Drive Extension”). The Steel Way Drive Extension shall be included on the land development plan for the proposed warehouse facility which is the subject of this application (the “Warehouse Development”), and Applicant shall provide financial security to secure completion of the Steel Way Drive Extension. The Steel Way Drive Extension shall meet all of the following requirements:

A. The Steel Way Drive Extension shall have a right-of-way width of 60 feet except for necessary turning radii at intersections.

B. If the Steel Way Drive Extension is not to be located within the right-of-way shown on the Final Subdivision and Land Development Plan for Greiner Industries, Inc., recorded at Subdivision Plan Book J-234, Page 14, and conveyed to the Township by Landowner in the Deed of Dedication dated April 18, 2008, and recorded at Document No. 5701997, Applicant must obtain the consent of the Board of Supervisors for such relocation and shall enter into necessary agreements to enable the relocation of the Steel Way Drive Extension.

C. If the Steel Way Drive Extension is not to be a new street intersecting with Steel Way Drive and proceeding northward, Applicant and Landowner shall, if requested by the Township, enter into an agreement to vacate the existing cul-de-sac turnaround and all portion of Steel Way Drive extending eastward of the Steel Way Drive Extension.

D. The Steel Way Drive Extension shall be completed (other than the final wearing course) prior to the issuance of an occupancy permit for the proposed warehouse building (the

“Warehouse”). The final wearing course for the Steel Way Drive Extension shall be installed within one year after the issuance of an occupancy certificate for the Warehouse.

E. The Steel Way Drive Extension shall be constructed to the standards of a collector road.

F. Applicant shall reimburse the Township for all costs associated with any agreements or other action necessary for the Steel Way Drive Extension including, but not limited to, the relocation (if necessary) of the Steel Way Drive Extension from the right-of-way previously conveyed to the Township, vacation of portions of existing Steel Way Drive, approvals from the Pennsylvania Department of Transportation (“PennDOT”) for the intersection of the Steel Way Drive Extension and Mount Pleasant Road; acceptance of the Steel Way Drive Extension, and imposition of traffic regulations on the Steel Way Drive Extension.

3. Applicant shall improve the existing intersection of Steel Way Drive and Cloverleaf Road to accommodate larger truck traffic associated with the Warehouse Development as set forth in the letter from TPD dated December 22, 2022, and as shown on the plan prepared by TPD date January 11, 2023 (the “Intersection Improvements”). At a minimum this shall include widening the cartway of Steel Way Drive for a distance of not less than 100 feet from the intersection with Cloverleaf Road; widening the turning radius from Cloverleaf Road on to Steel Way Drive, widening the cartway of Cloverleaf Road as shown on the plan prepared by TPD, and, if required by PennDOT, installation of turning lanes. Landowner shall convey the necessary right-of-way to the Township and, if required by PennDOT, to PennDOT for the Intersection Improvements. Applicant shall prepare all necessary plans to obtain a highway occupancy permit from PennDOT for the Intersection Improvements at its sole cost and expense. Applicant shall obtain the required highway occupancy permit for the Intersection Improvements prior to the release of the final plan for the Warehouse Development for recording and shall comply with all conditions which PennDOT may impose. Applicant shall complete the Intersection Improvements prior to the issuance of an occupancy certificate for the Warehouse.

4. Landowner shall dedicate additional right-of-way along the frontage of Mount Pleasant Road (SR 4010) to PennDOT or to the Township, as directed by PennDOT. Applicant shall install all improvements to Mount Pleasant Road required by PennDOT or required by the Subdivision and Land Development Ordinance, if allowed by PennDOT. It is the intent of this condition that Applicant install at a minimum all improvements required by the Subdivision and Land Development Ordinance unless PennDOT prohibits such work within its right-of-way.

5. Landowner shall dedicate additional right-of-way along the frontage of Stauffer Road to the Township to provide a 25 feet wide right-of-way from the centerline. Applicant and Landowner shall either install all required improvements to Stauffer Road or shall enter into a deferred improvements agreement relating to such improvements in a form acceptable to the Township Solicitor.

6. Applicant, at its sole cost and expense, shall prepare all necessary plans and legal descriptions for the dedication of additional right-of-way for Mount Pleasant Road and Stauffer Road.

7. Applicant shall obtain all necessary highway occupancy permits from PennDOT for access from the Property to Mount Pleasant Road, for the intersection of the Steel Way Drive Extension and Mount Pleasant Road, and for any storm water management facilities to be installed within the right-of-way of Mount Pleasant Road before a final plan for the Warehouse Development is released for recording. Applicant shall submit all applications to PennDOT to the Township for review and comment before submission to PennDOT.

8. No driveway access shall be permitted from the Property to Stauffer Road.

9. Applicant shall require all vehicles other than passenger cars, SUVs and pickup trucks (collectively "Personal Vehicles") leaving the Property to proceed westward to Cloverleaf Road on the Steel Way Drive Extension. All traffic other than Passenger Vehicles exiting the Property shall turn west on Mount Pleasant Road to the intersection of Mount Pleasant Road and the Steel Way Drive Extension. No traffic other than Personal Vehicles may leave the Property and travel eastward on Mount Pleasant Road. Applicant shall install and maintain signage informing drivers of this condition with wording and location of such signage acceptable to the Township Manager.

10. Applicant shall install and maintain barriers acceptable to the Township Engineer to prevent vehicles other than Passenger Vehicles from exiting the Property at either driveway on to Mount Pleasant Road and turning eastward. If it is not possible to design, install and maintain a barrier which will allow Passenger Vehicles to turn east on Mount Pleasant Road while preventing vehicles other than Passenger Vehicles to turn east on Mount Pleasant Road, then Applicant shall install barriers preventing all traffic from turning east on Mount Pleasant Road. The Zoning Hearing Board recognizes that PennDOT approval of any design is required, and the Township Engineer shall not unreasonably reject a design that includes barriers that substantially prohibit vehicles other than Passenger Vehicles (or both Passenger Vehicles and vehicles other than Passenger Vehicles) from turning east on Mount Pleasant Road when exiting the Property if PennDOT refuses to approve a more restrictive design.

11. Applicant shall install landscaping at the level shown on the plan submitted to the Township on December 22, 2022. All plants shall be native species which shall be identified during the land development process and approved by the Planning Commission. Applicant shall install native meadow pollinator plantings in open space areas. The land development plan shall identify all areas where native meadow pollinator plantings are proposed. Applicant and future owners of the Property shall maintain all vegetation shown on the landscaping plan submitted to the Township on December 22, 2022. Trees or shrubs which become diseased or die shall be replaced by landscaping meeting all Zoning Ordinance requirements and these conditions within six months.

12. Applicant shall install screening along the Mount Pleasant Road frontage opposite the tracts identified as 2754 Mount Pleasant Road and 2706 Mount Pleasant Road. Such screening shall include a landscaped berm with native trees.

13. The maximum impervious surface coverage on the Property for the development proposed by the application shall not exceed 60 percent.

14. All exterior mechanical and/or HVAC equipment shall be roof mounted. Applicant shall design the Warehouse to limit the visibility of any roof top mechanical equipment from the properties to the east. This may include architectural treatments which screen such equipment from the properties to the east. Applicant shall review the screening design with the Planning Commission as part of the land development approval process.

15. Applicant shall construct the Warehouse in general conformity with the architectural elevations presented as Exhibits A-8 and A-9 at the hearing on January 17, 2023.

16. The Warehouse will be provided with public water service and public sewer service.

17. The Warehouse shall be provided with an automatic fire suppression system.

18. Applicant shall prepare a fire prevention and mitigation plan prior to the issuance of an occupancy certificate for the Warehouse and shall provide the fire prevention and mitigation plan to emergency responders for their review and comment. This shall include, but not be limited to Northwest Regional Lancaster County Police Department, Fire Department Mount Joy, Rheems Fire Company, and Friendship Fire and Hose Company of Elizabethtown. Applicant shall include the reviewed fire prevention and mitigation plan with the application for an occupancy certificate for the Warehouse. Applicant and future operators of the Warehouse Development shall consult with emergency responders, not less than once each calendar year.

19. As part of the land development approval process Applicant present information on

how Applicant will provide a water supply for fire suppression, i.e. either through a water storage tank or by a connection for fire service to the Elizabethtown Area Water Authority ("EAWA") system. If Applicant shall provide a water storage tank, such tank shall be included on the land development plan and Applicant shall present evidence that the size of the water storage tank is adequate to meet Uniform Construction Code ("UCC") requirements. If Applicant proposes to use the EAWA system, Applicant shall provide a written third-party evaluation of the water supply requirements for fire protection of the proposed Warehouse which shall assess flow, duration, and volume requirements for supplying the Warehouse's automatic fire sprinkler system or system and for manual firefighting. Water supply calculations for the automatic sprinkler system shall include hose stream allowances (NFPA 13). The written evaluation shall also include calculations for the Warehouse's "Needed Fire Flow" derived using the Insurance Services Office formula. Additional pertinent calculations using other recognized methodology may be included as well. The written report shall include the raw data and formulas used for all calculations. Applicant shall conduct a flow test of the EAWA system being considered for fire protection use. The test shall be performed at a location proximal to the Property. Pressure, flow, and duration (volume capacity) data shall be included in the written report. Applicant shall include a sequential plan for installing infrastructure to provide the required fire flow(s) for the Warehouse with the land development plan. The plan shall include a construction timeline that assures availability of the necessary water pressure, flow, and volume for fire protection prior to the issuance of an occupancy certificate for the Warehouse. Included in the timeline shall be provisions for conducting a third-party flow test to verify the availability of adequate water supplies prior to the issuance of the occupancy certificate for the Warehouse.

20. Applicant shall provide Northwest Regional Lancaster County Police Department with the name and telephone number of an emergency contact person prior to the issuance of an occupancy certificate for the Warehouse. Applicant and future operators of the Warehouse Development shall regularly update such emergency contact information.

21. Applicant shall record a final plan to enable development under this decision no later than two years after the date of this Decision. All construction authorized by this Decision shall be completed no later than four years after the date of this Decision.

22. Applicant shall pay or shall post financial security to secure payment of traffic impact fees for not less than 147 new weekday p.m. peak hour trips prior to the issuance of a permit to enable

construction of the warehouse. If future information presented during the land development process demonstrates greater than 147 p.m. peak hour trips, Applicant shall pay impact fees based on that greater number. Applicant shall include a note on the land development plan acceptable to the Township Solicitor waiving any rights to request or receive a refund of all or any part of such impact fees. Applicant may enter into an agreement with the Township to allow Applicant to offset payment of impact fees by constructing improvements at the intersection of Steel Way Drive and Cloverleaf Road or to the Cloverleaf Road and Route 283 interchanges. Applicant shall not be entitled to use the costs to extend Steel Way Drive from its present termination to Mount Pleasant Road to offset payment of impact fees.

23. Applicant shall obtain all other necessary permits and approvals for the proposed development including, but not limited to, land development approval from the Township, storm water management plan approval from the Township, erosion and sedimentation control approval from the Lancaster County Conservation District and an NPDES permit. Applicant shall demonstrate that Applicant has obtained all required permits prior to the issuance of a zoning permit and Uniform Construction Code permit for the Warehouse.

24. If the Pennsylvania Department of Transportation requires that the Township be the applicant or co-applicant for any permit or approval, Applicant shall enter into an agreement with the Township pursuant to which Applicant shall be responsible for all costs associated with such permit application, completion of all improvements required by such PennDOT approval, and compliance with all conditions on the PennDOT approval. Such agreement shall be recorded and shall bind the Applicant, the Landowner, and all future owners of the Property.

25. Applicant shall reimburse the Township for reasonable costs of reviews by the Township Engineer and Township Solicitor of the special exception application and attendance at hearings before the Zoning Hearing Board, and for reasonable costs of review of plans and documents and, if necessary, costs of preparation and recording of the Storm Water Management Agreement, Agreement Providing for Grant of Conservation Easement, co-applicant agreements, or other documents by the Township Solicitor and for other reasonable fees and costs associated with the special exception application, and Subdivision and Land Development Ordinance, Storm Water Management Ordinance and PennDOT applications and plans and inspection of improvements, within 30 days after receipt of an invoice for such fees.

26. Applicant shall at all times comply with and adhere to the evidence presented to the Zoning

Hearing Board at the hearing on January 17, 2023, except as modified by these conditions. This shall include, but not be limited to, each finding of fact set forth in this Decision.

27. Any violation of the conditions contained in this Decision shall be considered a violation of the Zoning Ordinance and shall be subject to the penalties and remedies contained in the Pennsylvania Municipalities Planning Code.

28. The foregoing conditions shall be binding upon the Landowner, the Applicant and their respective personal representatives, heirs, successors and assigns.



## JARRED L. NEAL, PE

Project Manager

### YEARS OF EXPERIENCE

16 Years

### EDUCATION

Pennsylvania College of Technology  
B.S.C.E.T. / 2004 / Civil Engineering

Pennsylvania College of Technology  
A.S. Survey Tech. / 2004 / Land Surveying

### REGISTRATIONS

Professional Engineer – PA, VA, and MD

PA License # PE083971

VA License # 0402052156

MD License #45846

### PROFESSIONAL AFFILIATIONS

Mid-Atlantic Section of the Institute of Transportation Engineers  
(MASITE)

Institute of Transportation Engineers (ITE), member

### CONTINUING EDUCATION

The Bentley Institute, Microstation Design Basics, 2007

ASCE, Sediment Control, Erosion Prevention and Soil Stabilization, 2007

Transoft Solutions, Technical Presentations on Design, 2015

ITE, Focus on Pedestrians: Sidewalks and Crosswalks, 2015

PennDOT, Traffic Signals, 2016

### PERSONAL EXPERIENCE

Mr. Neal has experience in traffic engineering, transportation planning, and highway/signal design. His experience includes data collection, sight distance analyses, capacity analyses, signal-warrant analyses, queue length analyses, turn lane analyses, and parking/trip generation studies. He has also been responsible for managing and processing tasks associated with the Highway Occupancy Permit Review Assistance contract with PennDOT District 8-0. He also has worked on numerous Transportation Impact Studies and assists with PennDOT coordination and review of design projects.

### PROJECT EXPERIENCE

#### Transportation Impact Studies and Signal Design Studies, District-wide (District 8-0)

Preparation of traffic impact studies including signal warrant analysis, trip generation calculations, traffic modeling and simulation, parking studies, sight distance calculations and analysis, determination of traffic improvements and mitigation measures, auxiliary turn lane warrants, data collection, capacity analysis, queue length analysis, report preparation and interaction with project team, clients and reviewing agencies.. In addition, Mr. Neal is also responsible for proposal and addendums, project scheduling and project billing.

#### Highway Occupancy Permit Review Assistance

*District-wide (District 8-0)*

Responsible for the review of highway design plan sets and stormwater reports for Highway Occupancy Permit Applications in Adams, Cumberland, Dauphin, Franklin, Lancaster, Lebanon, Perry and York Counties.

#### GIANT Food Store Development

*Hampden Township, Cumberland County, PA*  
Traffic Study, Highway Design, Traffic Signal Design

#### West Shore Cancer Center

*Hampden Township, Cumberland County, PA*  
Traffic Study

#### GIANT Food Store Development

*Manheim Township, Lancaster County, PA*  
Traffic Study, Highway Design, Parking Study

#### Martin Elementary School

*Lancaster Township, Lancaster County, PA*  
Traffic Study, Highway Design, Traffic Signal Design

#### Members 1st Federal Credit Union

*West Lampeter Township, Lancaster County, PA*  
Traffic Study, Highway Design

#### Urban Outfitters Warehouse

*Salisbury Township, Lancaster County, PA*  
Traffic Study

#### Belmont Shopping Center

*Mahheim Township, Lancaster PA*  
Traffic Study, Highway Design, Traffic Signal Design, ROW







TRAFFIC PLANNING AND DESIGN, INC.

[WWW.TRAFFICPD.COM](http://WWW.TRAFFICPD.COM)

**December 22, 2022**

Justin Evans, Manager/Zoning Officer  
Mount Joy Township  
8853 Elizabethtown Road  
Elizabethtown PA, 17022

**RE: Zoning Hearing Board Application Traffic Evaluation**

PDC Northeast LPIV, LLC – Greiner Tract (2843 Mount Pleasant Road)

*Mount Joy Township, Lancaster County, PA*

TPD No. PANA.0001

Mr. Evans,

Traffic Planning and Design, Inc. (TPD) has completed a trip generation/zoning application traffic evaluation for the proposed PDC Northeast LPIV development located along Mount Pleasant Road (SR 4010) in Mount Joy Township, Lancaster County, PA. The proposed development is expected to consist of a 1,006,880 s.f. warehouse. Access for the development is proposed via two (2) full movement driveways to Mount Pleasant Road (SR 4010) with one access proposed directly opposite the proposed Steel Way extension as shown on the attached sketch plan.

The purpose of this evaluation is to calculate trip generation for the proposed development using typical trip generation methodologies and address pertinent traffic requirements within the zoning application.

**TRIP GENERATION**

**Methodology**

The trip generation equations for the proposed warehouse were obtained from the *Trip Generation Manual*, 11<sup>th</sup> Edition, an Institute of Transportation Engineers (ITE) Informational Report. The data are categorized by Land Use Codes, with total vehicular trips for a given land use estimated using an independent variable and statistically generated rates or equations.

For the proposed warehouse development, Land Use Code 150 (Warehousing) from the *Trip Generation Manual* was used to calculate the number of vehicular trips the development will generate during the following time periods: (1) average weekday; (2) weekday A.M. peak hour and (3) weekday P.M. peak hour.

**Table 1** shows the trip generation equations and directional split for the analyzed time periods.

TABLE 1  
ITE TRIP GENERATION DATA – TOTAL SITE TRIPS

Land Use	ITE #	Time Period	Average Rate	Directional Splits	
				Enter %	Exit %
Warehousing	150	Average Weekday	$T = 1.58 * (X) + 38.29$	50%	50%
		A.M. Peak Hour	$T = 0.12*(X) + 23.62$	77%	23%
		P.M. Peak Hour	$T = 0.12*(X) + 26.48$	28%	72%

*T = number of site-generated trips*

*X = independent variable (1000 s.f. of gross floor area)*

### Truck Trips

The truck trip generation for the proposed warehouse development was calculated utilizing Land Use Code 150 from the Trip Generate Manual, 11<sup>th</sup> Edition. The truck traffic volumes were deducted from the total warehouse trip generation to yield the passenger car traffic volumes. The proposed truck trip generation rates for this analysis are summarized in **Table 2**.

TABLE 2  
ITE TRUCK TRIP GENERATION RATES: WAREHOUSING

Land Use	ITE #	Time Period	Average Rate	Directional Splits	
				Enter %	Exit %
Warehousing	150	Average Weekday	$T = 0.60 * (X)$	50%	50%
		A.M. Peak Hour	$T = 0.02 * (X)$	52%	48%
		P.M. Peak Hour	$T = 0.03* (X)$	52%	48%

*T = number of site-generated truck trips*

*X = independent variable (1000 s.f. of gross floor area)*

The calculated trip generation for the proposed development is shown in **Table 3**.

TABLE 3  
TRIP GENERATION SUMMARY

Land Use	Time Period	Trips: Total			Trips: Trucks			Trips: Passenger Cars		
		Total	Enter	Exit	Total	Enter	Exit	Total	Enter	Exit
2483 Mt. Pleasant Road (1,006,880 s.f.)	Average Weekday	1629	815	814	605	302	303	1024	513	511
	A.M. Peak Hour	144	111	33	20	10	10	124	101	23
	P.M. Peak Hour	147	41	106	30	16	14	117	25	92

As shown in **Table 3**, the proposed development is anticipated to result in **144 new trips** during the weekday A.M. peak hour and **147 new trips** during the weekday P.M. peak hour.

## Mount Joy Township Zoning Application Traffic Requirements

The below is provided to address the traffic related sections of the zoning ordinance.

*§135-383.B(2) Traffic and public services. The applicant shall establish by credible evidence that the proposed special exception shall be properly serviced by all existing public service systems. The peak traffic generated by the subject of the application shall be accommodated in a safe and efficient manner or improvements made in order to effect the same. Similar responsibilities shall be assumed with respect to other public service systems, including but not limited to police protection, fire protection, utilities, parks and recreation.*

Based on the results of this evaluation, TPD offers the following:

- » The proposed warehouse is expected to generate 144 new weekday A.M. peak hour trips and 147 new weekday P.M. peak hour trips.
- » An extension of Steel Way is being provided to connect Cloverleaf Road (SR 4025) to Mt Pleasant Road (SR 4010). This improvement will reduce truck traffic at the intersection of Cloverleaf Road (SR 4025) to Mt Pleasant Road (SR 4010) which in existing conditions requires tight turning movements for trucks and occasionally forces trucks to extend into the oncoming lane to make the necessary turning movements. This improvement is being provided to reduce truck traffic at the Cloverleaf Road/Mt Pleasant Road intersection and provide for a safe and efficient route for existing and proposed truck traffic.
- » The existing intersection of Steel Way and Cloverleaf Road (SR 4025) is being widened and improved to accommodate larger truck traffic associated with this development as well as existing truck traffic currently using the roadway.
- » The driveways and internal circulation of the site will be designed to accommodate the necessary fire apparatus and/or largest public service vehicle. An emergency services truck turning template exhibit has been provided for reference.

In TPD's professional opinion, and for the purposes of this application, the proposed development can be served by the existing street network and associated roadway improvements and will not adversely impact the adjacent road system.

If you have any questions or require additional information, please call anytime.

Sincerely,

TRAFFIC PLANNING AND DESIGN, INC.



Jarred L. Neal, P.E.  
Senior Project Manager  
[Jneal@TrafficPD.com](mailto:Jneal@TrafficPD.com)

Attachments:  
Attachment 1 – Sketch Plan

Attachment 2 – Truck Turning Template Exhibit

**LEGEND**

- EDGE OF ROAD

- PROPOSED ROADWAY



© 2023 Traffic Planning and Design, Inc. All rights reserved. TPD-2023-001

**CONCEPT PLAN NOTES**

- THESE NOTES ARE AN INTEGRAL PART OF THIS CONCEPT PLAN. THIS CONCEPT PLAN HAS BEEN PREPARED AT CLIENT'S REQUEST, IS CONCEPTUAL AND PRELIMINARY IN NATURE, AND SHALL NOT BE USED FOR PURPOSES OF CONSTRUCTION OR ANY OTHER USE. THIS PLAN IS SUBJECT TO CHANGE AND REFINEMENT AS THE DESIGN IS FURTHER DEVELOPED AND REVIEWED BY MUNICIPALITIES, AGENCIES, AND OTHERS.
- ENGINEER DOES NOT MAKE ANY REPRESENTATION REGARDING THE ACCURACY OF THE INFORMATION CONTAINED HEREIN AND ACCEPTS NO LIABILITY FOR THE INFORMATION CONTAINED HEREIN.
- CLIENT MUST OBTAIN WRITTEN APPROVAL FROM PREPARER PRIOR TO RELEASE OF THIS PLAN TO ANY THIRD PARTY. ANY OTHER USE BY A THIRD PARTY IS STRICTLY PROHIBITED.
- THIS CONCEPT PLAN IS BASED ON UNVERIFIED SURVEY/MAPPING INFORMATION PROVIDED TO PREPARER BY OTHERS. FINAL PROJECT DESIGN SHALL BE BASED ON ACTUAL SURVEY PREPARED UNDER THE SUPERVISION AND CONTROL OF A PROFESSIONAL LICENSED SURVEYOR.
- ANY RIGHT-OF-WAY LINES OR PROPERTY LINES DEPICTED ON THIS PLAN ARE UNVERIFIED AND MUST BE CONFIRMED BY A PROFESSIONAL LICENSED SURVEYOR. EVEN IF NOT DEPICTED HEREIN, RIGHT-OF-WAY OR EASEMENT ACQUISITIONS MAY BE NECESSARY AS PART OF THIS PROJECT. FINAL RIGHT-OF-WAY OR EASEMENT ACQUISITIONS SHALL BE BASED ON ENGINEERED AND APPROVED PLANS.

- ANY UTILITY FACILITIES DEPICTED ON THIS PLAN ARE UNVERIFIED AND MUST BE CONFIRMED THROUGH SURVEY AND UTILITY RESEARCH. SUBSURFACE UTILITY ENGINEERING MAY BE NECESSARY TO ACCURATELY LOCATE UNDERGROUND UTILITY FACILITIES. EVEN IF NOT DEPICTED HEREIN, UTILITY RELOCATIONS MAY BE NECESSARY AS PART OF THIS PROJECT. UTILITY RELOCATIONS SHALL BE BASED ON ENGINEERED AND APPROVED PLANS.
- ANY ENVIRONMENTAL RESOURCES DEPICTED ON THIS PLAN ARE UNVERIFIED AND MUST BE CONFIRMED THROUGH RESEARCH, FIELD SURVEYS, AND STUDIES. EVEN IF NOT DEPICTED HEREIN, ENVIRONMENTAL RESOURCES MAY BE IMPACTED AS PART OF THIS PROJECT. THIS CONCEPT PLAN DOES NOT PURPORT TO CONSIDER ALL ENVIRONMENTAL RESOURCE IMPACTS THAT MAY BE REQUIRED DUE TO ANY PROPOSED IMPROVEMENTS.
- ANY ROADWAY STRUCTURES (E.G. BRIDGES, CULVERTS, RETAINING WALLS) DEPICTED ON THIS PLAN ARE UNVERIFIED AND MUST BE CONFIRMED THROUGH RESEARCH, FIELD SURVEYS, AND STUDIES. EVEN IF NOT DEPICTED HEREIN, ROADWAY STRUCTURES MAY BE IMPACTED AS PART OF THIS PROJECT. THIS CONCEPT PLAN DOES NOT PURPORT TO CONSIDER ALL IMPACTS TO ROADWAY STRUCTURES THAT MAY BE REQUIRED DUE TO ANY PROPOSED IMPROVEMENTS.

- ALTHOUGH NOT NECESSARILY DEPICTED ON THIS CONCEPT PLAN, DRAINAGE AND STORMWATER MANAGEMENT IMPROVEMENTS MAY BE NECESSARY IN ORDER TO IMPLEMENT ANY PROPOSED IMPROVEMENTS.
- ALL DOCUMENTS, DESIGNS, DRAWINGS AND SPECIFICATIONS ("INSTRUMENTS OF SERVICE") PREPARED SPECIFICALLY FOR THIS PROJECT BY PREPARER ("ENGINEER") ARE NOT INTENDED OR REPRESENTED TO BE SUITABLE FOR USE BY CLIENT OR ANYONE ELSE ON FURTHER DEVELOPMENT OF THE PROJECT OR ON ANY OTHER PROJECT. IN ACCEPTING AND UTILIZING INSTRUMENTS OF SERVICE, OR ANY FORM OF ELECTRONIC MEDIA GENERATED AND PROVIDED BY ENGINEER WITH RESPECT TO THIS PROJECT, ANY REUSE OR MODIFICATION OF INSTRUMENTS OF SERVICE WITHOUT WRITTEN CONSENT BY ENGINEER FOR THE SPECIFIC PURPOSE INTENDED WILL BE AT CLIENT'S SOLE RISK AND WITHOUT LIABILITY ON LEGAL EXPOSURE TO ENGINEER. CLIENT AGREES TO WAIVE ALL CLAIMS AGAINST ENGINEER RESULTING IN ANY WAY FROM ANY UNAUTHORIZED CHANGES OR REUSE OF INSTRUMENTS OF SERVICE BY ANYONE OTHER THAN ENGINEER. IN ADDITION, CLIENT AGREES, TO THE FULLEST EXTENT PERMITTED BY LAW, TO INDEMNIFY, DEFEND AND HOLD ENGINEER HARMLESS FROM ANY DAMAGE, LIABILITY, OR COSTS, INCLUDING REASONABLE ATTORNEYS' FEES AND COSTS OF DEFENSE, ARISING FROM ANY UNAUTHORIZED REUSE OR CHANGES TO INSTRUMENTS OF SERVICE.



www.TrafficPD.com | 1.877.873.9739 | TPD@TrafficPD.com

DISTRICT	COUNTY	ROUTE	SECTION	SHEET
8-0	LANCASTER	4025	--	1 OF 1

**CONCEPT PLAN**

01/11/2023