

February 2023  
Revised March 2023

**VOLUME 1**

**TRANSPORTATION IMPACT STUDY**

for

**MOUNT JOY TOWN CENTER**

on

**Existing Commercially Zoned Land**

in

**Mount Joy Township  
Lancaster County, Pennsylvania**

Prepared for:

Penmark Management Company, Inc  
1000 Germantown Pike, Suite A-2  
Plymouth Meeting, PA 19462

Prepared by:

Grove Miller Engineering, Inc.  
Gregory E. Creasy, P.E.  
4800 Linglestown Road, Suite 307  
Harrisburg, PA 17112  
(717) 545-3636  
[www.grovemiller.com](http://www.grovemiller.com)

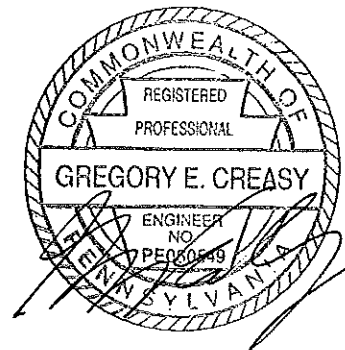

## TABLE OF CONTENTS

	Page
EXECUTIVE SUMMARY . . . . .	1
INTRODUCTION . . . . .	6
Land Use Context . . . . .	7
Study Area Transportation Facilities . . . . .	7
Study Area Map . . . . .	8
Site Plan . . . . .	8
DATA COLLECTION . . . . .	9
EXISTING STUDY AREA CONDITIONS . . . . .	10
Roadway Network . . . . .	10
SR 0230 . . . . .	10
Cloverleaf Road (SR 4025) . . . . .	11
Ridge Run Road (T-327) . . . . .	11
Maytown Road (SR 0743) . . . . .	11
Groff Avenue . . . . .	11
Sheaffer Road (T-888) . . . . .	12
Harrisburg Avenue (SR 4018) . . . . .	12
Andrew Avenue . . . . .	12
Norlanco Drive . . . . .	12
Schwanger Road . . . . .	12
Merts Drive . . . . .	13
Volumes and Capacity . . . . .	13
Pedestrian/Bicycle Facilities . . . . .	13
Transit Facilities . . . . .	13
OPENING YEAR CONDITIONS WITHOUT DEVELOPMENT . . . . .	14
Background Growth Factors . . . . .	14
Adjacent Development Traffic . . . . .	14
Capacity Analysis . . . . .	14
HORIZON YEAR CONDITIONS WITHOUT DEVELOPMENT . . . . .	15
Background Growth Factors . . . . .	15
Adjacent Development Traffic . . . . .	15
Capacity Analysis . . . . .	15
DEVELOPMENT DESCRIPTION . . . . .	15
Site Narrative . . . . .	15
Sight Distance Analysis . . . . .	16
Trip Generation . . . . .	18
Pass-By Trips . . . . .	19
Internal Capture Trips . . . . .	19
Trip Distribution/Assignment . . . . .	19
OPENING YEAR CONDITIONS WITH DEVELOPMENT . . . . .	19
Volumes and Capacity Analysis . . . . .	19
HORIZON YEAR CONDITIONS WITH DEVELOPMENT . . . . .	20
Volumes and Capacity Analysis . . . . .	20
Traffic Signal Warrant Analyses . . . . .	20
Queue Analysis . . . . .	20

Left Turn Lane Analyses . . . . .	21
Right Turn Lane Analyses. . . . .	21
MITIGATION IDENTIFICATION AND RECOMMENDATIONS . . . . .	21
Alternative Transportation Plan. . . . .	22
CONCLUSIONS AND RECOMMENDATIONS . . . . .	22

APPENDICES

A: Summary of Results

    Table 1: Levels of Service Summary

    Table 2: Queue Length Summary

B: Existing Conditions

    Figure 1: Location Map

    Figure 2: Site Plan

    Figure 3a: Existing Traffic Volumes, AM Peak Hour

    Figure 3b: Existing Traffic Volumes, PM Peak Hour

    Figure 3c: Existing Traffic Volumes, Saturday Peak Hour

    Figure 3d: Traffic Signal Permit Plans

    Figure 4a: New Trip Distribution

    Figure 4b: Pass-By Trip Distribution

C: Opening Year Conditions

    Figure 5a: 2024 Opening Year Traffic Volumes, No Build

    Figure 5b: 2024 Opening Year Traffic Volumes, Build

D: Horizon Year Conditions

    Figure 6a: 2029 Horizon Year Traffic Volumes, No Build

    Figure 6b: 2029 Horizon Year Traffic Volumes, Build

E: Existing Transportation Conditions

F: Study Area Photographs

G: Committed Developments

H: Turning Movement/ATR Counts

I: Growth Rate Information

J: Trip Generation Calculations Worksheets

K: Traffic Volume Spreadsheets

L: Capacity and Queue Analysis Worksheets

M: Turn Lane Analysis Worksheets

N: Sight Distance Analysis Worksheets

O: Traffic Signal Warrant Analysis Worksheets

P: Correspondence

## EXECUTIVE SUMMARY

A retail development, Mount Joy Town Center, is proposed for a tract of land in Mount Joy Township, Lancaster County. The site is located in the northeast corner of the intersection of SR 0230 and Cloverleaf Road (SR 4025). This Transportation Impact Study (TIS) was performed assuming the following land uses:

Convenience Store with Gasoline Pumps  
127,000 square feet of general retail space

It is noted that the current plans shows approximately 105,000 square feet of general retail space, so the trip generation projections used in this TIS result in conservative analyses.

Currently proposed access locations are as follows:

- 1) Signalized access onto SR 0230 located approximately 1,050 feet east of Cloverleaf Road via extension of Norlanco Drive
- 2) Right-in only driveway onto Cloverleaf Road on north side of convenience store parcel
- 3) Right-In/Right-Out Driveway onto Cloverleaf Road located 550 feet north of SR 0230
- 4) Right-In Only Driveway onto SR 0230 on the east side of the convenience store lot located approximately 425 feet from the stop bar at the signalized intersection of SR 0230/Cloverleaf Road

This TIS was prepared for a 2024 Opening Year and a 2029 Horizon Year. The following conclusions and recommendations are provided for the study area and the study area intersections:

### **SR 0230 and SR 0743 (Maytown Road)**

- No improvements are necessary to mitigate the impact of traffic from the proposed development.

### **SR 0230 and Groff Avenue**

- Level of service deficiencies exist at this intersection and will continue in the future traffic projections without or with traffic from the proposed development. Many of the residential developments that were included in the background traffic projections will contribute to traffic volumes at this intersection as well.

### **SR 0230 and Giant Plaza Driveway/Carey Lane**

- No improvements are necessary to mitigate the impact of traffic from the proposed development.

### **SR 0230 and Speedway Driveway/Market Square Driveway**

- No improvements are necessary to mitigate the impact of traffic from the proposed development.

### **SR 0230 and Sheaffer Road**

- No improvements are necessary to mitigate the impact of traffic from the proposed development.

### **SR 0230 and Cloverleaf Road/Colebrook Road**

- Minor traffic signal timing adjustments can mitigate impacts of the proposed development traffic.

### **SR 0230 and Ridge Run Road**

- No improvements are necessary to mitigate the impact of traffic from the proposed development.

### **Colebrook Road and Harrisburg Avenue**

- Installation of traffic signal control is required to mitigate the impact of traffic from the proposed development. It is noted that traffic signal installation at this intersection is identified as a future intersection improvement in the Mount Joy Township Capital Improvements Plan.

### **Cloverleaf Road and Andrew Avenue/Norlanco Drive**

- Construction of a 150-foot northbound left turn lane and a 275-foot southbound left turn lane on Cloverleaf Road is necessary to mitigate impacts of the proposed development traffic. It is noted that these left turn lanes are identified as future intersection improvements in the Mount Joy Township Capital Improvements Plan.

### **Cloverleaf Road and Schwanger Road**

- Minor traffic signal timing adjustments can mitigate impacts of the proposed development traffic.

### **Cloverleaf Road and Merts Drive**

- No improvements are necessary to mitigate the impact of traffic from the proposed development.

### **Cloverleaf Road and PA Route 283 Eastbound Ramps**

- Level of service deficiencies exist at this intersection and will continue in the future traffic projections without or with traffic from the proposed development. The Mount Joy Township Capital Improvements Plan identifies improvement options for the PA Route 283/Cloverleaf Road interchange. Completion of those improvements by any individual development is not feasible. Traffic Impact Fees collected by the Township for this project can be applied to those improvement solutions.

### **Cloverleaf Road and PA Route 283 Westbound Ramps**

- No improvements are necessary to mitigate the impact of traffic from the proposed development.

### **SR 0230 and Right-In Access (near Convenience Store)**

- Right turn lane analyses indicate that a 150-foot westbound right turn lane, with a 100-foot taper, is warranted along SR 0230 for traffic entering the proposed Right-In Access using 2029 Horizon Year traffic volumes.

### **SR 0230 and Norlanco Drive Extension**

- Installation of traffic signal control is necessary to provide adequate levels of service at this proposed intersection. A 175-foot westbound right turn lane, with a 100-foot taper, will be constructed to accommodate traffic entering the Norlanco Drive Extension. The existing two-way center left turn only lane will be restriped to show a 250-foot eastbound left turn lane. Two (2) exiting lanes will be provided on the Norlanco Drive Extension.

- Sight distances for traffic entering and exiting the Norlanco Drive Extension are in excess of PennDOT sight distance criteria.

### **Cloverleaf Road and Right-In Access (near Convenience Store)**

- Right turn lane analyses indicate that a 150-foot northbound right turn lane, with a 100-foot taper, is warranted along Cloverleaf Road for traffic entering the proposed Right-In Access using 2029 Horizon Year traffic volumes.

### **Cloverleaf Road and Eastern Parcels Access**

- The Eastern Parcels Access will be designed to permit right-in/right-out movements.

- A raised, mountable-curb pork-chop island will be provided to restrict entering and exiting left turn movements.
  
- It is recommended that STOP (R1-1, 30"x30") and NO LEFT TURN (R3-2, 30"x30") be provided on the proposed Eastern Parcels Access approach for traffic exiting the development site.



## INTRODUCTION

A retail development, Mount Joy Town Center, is proposed for a tract of land in Mount Joy Township, Lancaster County. The site is located in the northeast corner of the intersection of SR 0230 and Cloverleaf Road (SR 4025). This Transportation Impact Study (TIS) was performed assuming the following land uses:

Convenience Store with Gasoline Pumps  
127,000 square feet of general retail space

It is noted that the current plans shows approximately 105,000 square feet of general retail space, so the trip generation projections used in this TIS result in conservative analyses.

Currently proposed access locations are as follows:

- 1) Signalized access onto SR 0230 located approximately 1,050 feet east of Cloverleaf Road via extension of Norlanco Drive
- 2) Right-in only driveway onto Cloverleaf Road on north side of convenience store parcel
- 3) Right-In/Right-Out Driveway onto Cloverleaf Road located 550 feet north of SR 0230
- 4) Right-In Only Driveway onto SR 0230 on the east side of the convenience store lot located approximately 425 feet from the stop bar at the signalized intersection of SR 0230/Cloverleaf Road

The following report contains analysis, conclusions, and recommendations for accommodation of traffic volumes anticipated to be generated by the proposed development site.

Grove Miller Engineering, Inc. has been retained by Penmark Management Company, Inc. to conduct a TIS for the development site. The scope of the TIS was confirmed by PennDOT and Mount Joy Township. Study scope documentation and study correspondence are included in Appendix P. The study methodology and traffic analyses documented in this transportation impact study report are in accordance with guidelines in Appendix A - Policies and Procedures for Transportation Impact Studies Related to Highway Occupancy Permits of Publication 282, dated July 2017 and Township SALDO requirements.

### **Land Use Context**

The development site is located in an area defined by PennDOT as an Urban Area. When the existing land use of the proposed development site and the land uses of the properties immediately surrounding the site are considered, the area can be defined as a Suburban Corridor and SR 0230 and Cloverleaf Road (SR 4025) can be considered Community Arterials based upon criteria in Publication 10X (Design Manual Part 1X), Appendix B.

### **Study Area Transportation Facilities**

Based on the scoping process, the study area consists of the following intersections:

- SR 0230 and SR 0743 (Maytown Road)
- SR 0230 and Groff Avenue
- SR 0230 and Giant Plaza Driveway/Carey Lane
- SR 0230 and Speedway Driveway/Market Square Driveway
- SR 0230 and Sheaffer Road
- SR 0230 and Cloverleaf Road/Colebrook Road
- SR 0230 and Ridge Run Road
- Colebrook Road and Harrisburg Avenue
- Cloverleaf Road and Andrew Avenue/Norlanco Drive
- Cloverleaf Road and Schwanger Road

- Cloverleaf Road and Merts Drive
- Cloverleaf Road and PA 283 Eastbound Ramps
- Cloverleaf Road and PA 283 Westbound Ramps
- SR 0230 and Right-In Access (near Convenience Store)
- SR 0230 and Norlanco Drive Extension
- Cloverleaf Road and Right-In Access (near Convenience Store)
- Cloverleaf Road and Eastern Parcels Access

Photographs of the study area intersections are provided in Appendix F, while documentation of existing roadway conditions and transportation facilities are included in Appendix E.

There are no existing sidewalks along SR 0230 or Cloverleaf Road in the area of the development site. Pedestrian accommodations are provided at the signalized intersection of SR 0230 and Cloverleaf Road. Bicycles share the roadway with passenger vehicles, trucks, and busses.

### **Study Area Map**

A map showing the study area and the proposed site location is provided in Appendix B, Figure 1.

### **Site Plan**

The site plan depicts the current development proposal of a convenience store with gasoline pumps and general retail space. It is noted that the current plans shows approximately 105,000 square feet of general retail space, so the trip generation projections used in this TIS result in conservative analyses.

Currently proposed access locations are as follows:

- 1) Signalized access onto SR 0230 located approximately 1,050 feet east of Cloverleaf Road via extension of Norlanco Drive
- 2) Right-in only driveway onto Cloverleaf Road on north side of convenience store parcel
- 3) Right-In/Right-Out Driveway onto Cloverleaf Road located 550 feet north of SR 0230
- 4) Right-In Only Driveway onto SR 0230 on the east side of the convenience store lot located approximately 425 feet from the stop bar at the signalized intersection of SR 0230/Cloverleaf Road

This TIS was prepared for a 2024 Opening Year and a 2029 Horizon Year.

## **DATA COLLECTION**

Manual turning movement counts (TMC) were conducted at the following study area intersections:

- SR 0230 and SR 0743 (Maytown Road)
- SR 0230 and Groff Avenue
- SR 0230 and Giant Plaza Driveway/Carey Lane
- SR 0230 and Speedway Driveway/Market Square Driveway
- SR 0230 and Sheaffer Road
- SR 0230 and Cloverleaf Road/Colebrook Road
- SR 0230 and Ridge Run Road
- Colebrook Road and Harrisburg Avenue
- Cloverleaf Road and Andrew Avenue/Norlanco Drive
- Cloverleaf Road and Schwanger Road
- Cloverleaf Road and Merts Drive
- Cloverleaf Road and PA 283 Eastbound Ramps
- Cloverleaf Road and PA 283 Westbound Ramps

The TMC were conducted during the weekday morning (6:00 AM to 9:00 AM), weekday afternoon (3:00 PM to 6:00 PM), and Saturday (11:00 AM to 2:00 PM) peak periods. The TMC traffic counts were conducted in March 2022. No seasonal adjustments were applied to the raw count data.

Automatic traffic recorder (ATR) counts were conducted along SR 0230, Cloverleaf Road, and Ridge Run Road in the area of the development site. The TMC and ATR data sheets are provided in Appendix H.

## EXISTING STUDY AREA CONDITIONS

The area around the proposed development is within an urban boundary but is more characteristic of a suburban corridor. SR 0230 and Cloverleaf Road (SR 4025) are the major roadways providing access to the development site.

### Roadway Network

The study area includes the following roadways:

**SR 0230.** SR 0230 is a three-lane roadway (one lane in each direction and a center left-turn only lane) running in an east/west direction south of and adjacent to the development site. The roadway is classified as a Community Arterial using Publication 10X (Design Manual 1X), Appendix B. The current average daily traffic (ADT) volume on SR 0230 is approximately 10,000 vehicles per day in the vicinity of the proposed development site. Pavement markings consist of a yellow center left-turn only pattern and white edge lines. The posted speed limit along SR 0230 is 45 miles per hour (mph) along the western development frontage (west of Cloverleaf Road) and for approximately 1,500 feet east of Cloverleaf Road. The posted speed limit to the east of that location (along the eastern development frontage) is 55 mph..

**Cloverleaf Road (SR 4025).** Cloverleaf Road is a two-lane roadway running in a north/south direction adjacent to the development site. Cloverleaf Road is designated as SR 4025 through the study area. The roadway is classified as a Community Arterial using Publication 10X (Design Manual 1X), Appendix B. The current ADT volume on Cloverleaf Road is approximately 16,000 vehicles per day in the vicinity of the proposed development site. Pavement markings consist of a double yellow center line and white edge lines. The posted speed limit along Cloverleaf Road is 40 mph in the area of the development site.

**Ridge Run Road (T-327).** Ridge Run Road is a two-lane roadway running in a north/south direction east of and adjacent to the development site. Ridge Run Road is designated as T-327. The roadway is classified as a Local Road using Publication 10X (Design Manual 1X), Appendix B. The current ADT volume on Ridge Run Road is approximately 775 vehicles per day in the vicinity of the proposed development site. Pavement markings consist of a double yellow center line. The posted speed limit along Ridge Run Road is 35 mph in the area of the development site.

**Maytown Road (SR 0743).** Maytown Road is a two-lane roadway running in a north/south direction west of the development site. Maytown Road is designated as SR 0743 through the study area. Pavement markings consist of a double yellow center line and white edge lines. The posted speed limit along Maytown Road is 35 mph in the area of SR 0230.

**Groff Avenue.** Groff Avenue is a two-lane roadway running in a north/south direction west of the development site. Groff Avenue is a Borough street. Pavement markings consist of a double yellow center line. The posted speed limit along Groff Avenue is 35 mph in the area of SR 0230.

**Sheaffer Road (T-888).** Sheaffer Road is a two-lane roadway running in a north/south direction west of the development site. Sheaffer Road is designated as T-888 in the study area. Pavement markings consist of a double yellow center line. The posted speed limit along Sheaffer Road is 35 mph in the area of SR 0230.

**Harrisburg Avenue (SR 4018).** Harrisburg Avenue is a two-lane roadway running in an east/west direction south of the development site. Harrisburg Avenue is designated as SR 4018 through the study area. Pavement markings consist of a double yellow center line and white edge lines. The posted speed limit along Harrisburg Avenue is 35 mph in the area of Cloverleaf Road.

**Andrew Avenue.** Andrew Avenue is a two-lane roadway running in an east/west direction west of the development site. Andrew Avenue is designated as T-351 through the study area. Pavement markings consist of a double yellow center line in the area of Cloverleaf Road. The posted speed limit along Andrew Avenue is 25 mph in the area of Cloverleaf Road.

**Norlanco Drive.** Norlanco Drive is a two-lane roadway running in an east/west direction north of the development site. Norlanco Drive is designated as T-351 through the study area. Pavement markings consist of a double yellow center and white edge lines. The posted speed limit along Norlanco Drive is 25 mph in the area of Cloverleaf Road.

**Schwanger Road.** Schwanger Road is a two-lane roadway running in an east/west direction north of the development site. Schwanger Road is designated as T-843 through the study area. Pavement markings consist of a double yellow center line and white edge lines. The posted speed limit along Schwanger Road is 35 mph in the area of SR Cloverleaf Road.

**Merts Drive.** Merts Drive is a two-lane roadway running in an east/west direction north of the development site. Merts Drive is designated as T-833 through the study area. Pavement markings consist of a double yellow center line and white edge lines. The posted speed limit along Merts Drive is 25 mph in the area of Cloverleaf Road.

Existing traffic signal permit plans are provided in Appendix B, Figure 3d.

### **Volumes and Capacity**

Capacity and queue analyses were completed using Synchro Software, Version 11.1, Build 2, Revision 9. The existing coordination or MAX signal times were utilized for existing conditions. Capacity analyses for existing conditions at study area intersections are summarized in Appendix A, Table 1. Existing traffic volumes and levels of service at study area intersections are shown in Appendix B, Figures 3a through 3c. The capacity analyses worksheets are provided in Appendix L.

### **Pedestrian/Bicycle Facilities**

There are no existing sidewalks along SR 0230 or Cloverleaf Road in the area of the development site. Pedestrian accommodations are provided at the signalized intersection of SR 0230 and Cloverleaf Road. Bicycles share the roadway with passenger vehicles, trucks, and busses.

### **Transit Facilities**

Red Rose Transit Route 18 currently provides service to the study area, including a stop at the intersection of SR 0230 and Cloverleaf Road (SR 4025). The applicant is working with the transit service about providing a bus stop along the SR 0230 site frontage.



## **OPENING YEAR CONDITIONS WITHOUT DEVELOPMENT**

Traffic analyses conducted for conditions without the development are documented in this report section. The 2024 Opening Year was analyzed.

### **Background Growth Factors**

Traffic projections were made in order to account for growth in background traffic volumes which may result from other future, potential development in the region. The 2022 traffic count volumes were projected to the 2024 Opening Year using a 0.60 percent annual traffic growth rate. The traffic growth rate was referenced from growth factor data provided by the PennDOT Bureau of Planning and Research and is documented in Appendix I. Opening Year traffic volumes are shown in Appendix C, Figure 5a. Traffic volume projections are documented in spreadsheet format in Appendix K.

### **Adjacent Development Traffic**

The Township provided information regarding six (6) other development projects in the area. The developments are: Featherton 5, 1376 Campus Road, 1925 Sheaffer Road, Westbrooke IV, Raffensperger, and Westmount. Traffic for these developments was included in the traffic projections where appropriate (TIS submitted to the Township prior to the TIS submission for this development).

### **Capacity Analysis**

Capacity and queue analyses were completed using Synchro Software, Version 11.1, Build 2, Revision 9. Traffic signal timings were optimized for No Build conditions. Capacity analyses for the Opening Year without development conditions at study area intersections are summarized in Appendix A, Table 1. The capacity and queue analyses worksheets are provided in Appendix L.

## **HORIZON YEAR CONDITIONS WITHOUT DEVELOPMENT**

Traffic analyses conducted for conditions without the development are documented in this report section. The 2029 Horizon Year was analyzed.

### **Background Growth Factors**

Traffic projections were made for the Horizon Years in a similar manner as the projections for the Opening Years as defined in the previous report section. Horizon Year traffic volumes are shown in Appendix D, Figure 6a.

### **Adjacent Development Traffic**

Adjacent developments, as defined in the previous report sections, were included in the traffic projections.

### **Capacity Analysis**

Capacity and queue analyses were completed using Synchro Software, Version 11.1, Build 2, Revision 9. Traffic signal timings were optimized for No Build conditions. Capacity analyses for Horizon Year conditions at study area intersections are summarized in Appendix A, Table 1. The capacity and queue analyses worksheets are provided in Appendix L.

## **DEVELOPMENT DESCRIPTION**

### **Site Narrative**

A retail development, Mount Joy Town Center, is proposed for a tract of land in Mount Joy Township, Lancaster County. The site is located in the northeast corner of the intersection of SR 0230 and Cloverleaf Road (SR 4025). This Transportation Impact Study (TIS) was performed assuming the following land uses:

Convenience Store with Gasoline Pumps  
127,000 square feet of general retail space

It is noted that the current plans shows approximately 105,000 square feet of general retail space, so the trip generation projections used in this TIS result in conservative analyses.

Currently proposed access locations are as follows:

- 1) Signalized access onto SR 0230 located approximately 1,050 feet east of Cloverleaf Road via extension of Norlanco Drive
- 2) Right-in only driveway onto Cloverleaf Road on north side of convenience store parcel
- 3) Right-In/Right-Out Driveway onto Cloverleaf Road located 550 feet north of SR 0230
- 4) Right-In Only Driveway onto SR 0230 on the east side of the convenience store lot located approximately 425 feet from the stop bar at the signalized intersection of SR 0230/Cloverleaf Road

The land use at and surrounding the site is suburban based on the criteria discussed in Publication 10X (Design Manual 1X), Appendix B and will not change as a result of the proposed development.

This TIS was prepared for a 2024 Opening Year and a 2029 Horizon Year.

### **Sight Distance Analysis**

Sight distances were evaluated at the proposed site access locations onto SR 0230 and Cloverleaf Road to determine if available lines of sight meet PennDOT sight distance criteria. Sight distances were measured and compared with the published safe sight distance criteria in AASHTO or PennDOT Regulations Chapter 441 as necessary. A summary of sight distance criteria and measurements for the intersections can be found in Tables 3 and 4.

Table 3. Sight Distance Evaluation Summary:  
 SR 0230 and Norlanco Drive Extension

Location	Direction	Observed Sight Distance (ft)	Required Sight Distance (ft)	Acceptable
Norlanco Drive Extension @ SR 0230	Left (east)	1,000+	430 <sup>(1)</sup>	YES
	Right (west)	1,000+	500 <sup>(2)</sup>	YES
vehicle approaching from rear on major street	EB	1,000+	376 <sup>(3)</sup>	YES
left turn from major street	EB left	960	365 <sup>(4)</sup>	YES

(1) AASHTO, Table 9-8

(2) AASHTO, Table 9-6

(3) Minimum safe stopping sight distance

(4) AASHTO, Table 9-14

Table 4. Sight Distance Evaluation Summary:  
 Cloverleaf Road and Eastern Parcels Access

Location	Direction	Observed Sight Distance (ft)	Required Sight Distance (ft)	Acceptable
Eastern Parcels Access @ Cloverleaf Road	Left (south)	500	540 <sup>(1)</sup> 304 <sup>(2)</sup>	YES
	Right (north)	N/A	N/A	YES
vehicle approaching from rear on major street	SB	497	325 <sup>(2)</sup>	YES
left turn from major street	SB left	472	375 <sup>(3)</sup>	YES

(1) Ch 441, Table 1

(2) Minimum safe stopping sight distance

(3) Ch 441, Table 5

The sight distance evaluations indicate that the lines of sight at the proposed site access locations are acceptable and provide for safe traffic movements.

Documentation of sight distance evaluations is provided in Appendix N.

### Trip Generation

The Institute of Transportation Engineers (ITE), Trip Generation Manual, 11th Edition (2021) was used to estimate the number of trips which could be generated by the Mount Joy Town Center site. Table 5 summarizes the trip generation projections for the site, and trip generation calculation worksheets are provided in Appendix J.

Table 5. Proposed Land Use and Trip Generation Summary

Land Use (Code)	Daily Trips	Peak Hour Trips					
		AM Enter	AM Exit	PM Enter	PM Exit	SAT Enter	SAT Exit
Retail (821)	11,213	279	171	526	570	557	536
Pass-By Trips	–	0	0	210	228	173	166
New Trips	–	279	171	316	342	384	370
Conv. Store (945)	3,690	189	190	161	162	175	182
Pass-By Trips	–	144	144	121	121	114	118
New Trips	–	45	46	40	41	61	64
<b>Total Site Trips</b>	<b>14,903</b>	<b>468</b>	<b>361</b>	<b>687</b>	<b>732</b>	<b>732</b>	<b>718</b>
<b>Total Pass-By Trips</b>	<b>–</b>	<b>144</b>	<b>144</b>	<b>331</b>	<b>349</b>	<b>287</b>	<b>284</b>
<b>Total New Trips</b>	<b>–</b>	<b>324</b>	<b>217</b>	<b>356</b>	<b>383</b>	<b>445</b>	<b>434</b>

For the Convenience Store land use, trip generation calculations were performed using the number of vehicle fueling positions category with the building square footage as the secondary variable, and then with the building square footage category with the number of fueling positions as the secondary variable to determine the most conservative estimates. The most conservative estimate was used in the trip generation projections.

## Pass-By Trips

Pass-By Trips are applicable to land uses associated with this development and were applied based on the following percentages:

- Shopping Plaza (40,000-150,000 sq. ft.) - 40% PM, 31% SAT
- Convenience Store - 76% AM, 75% PM, 65% SAT (assume 10% less than PM)

Documentation is provided in Appendix J.

## Internal Capture Trips

Internal capture trips are applicable to the proposed land uses.

## Trip Distribution/Assignment

New and pass-by trips generated by the proposed development were distributed onto the surrounding roadway network based on gravity models as approved during the TIS Scoping Application process. The trip distributions for the peak hours are shown in Appendix B, Figures 4a and 4b. Additional trip distribution documentation is provided in Appendix K.

## OPENING YEAR CONDITIONS WITH DEVELOPMENT

Traffic analyses conducted for conditions with the development are documented in this report section. The 2024 Opening Year was analyzed.

## Volumes and Capacity Analysis

Capacity and queue analyses were completed using Synchro Software, Version 11.1, Build 2, Revision 9. The traffic signal timings that were optimized for No Build conditions were utilized for Build conditions. Capacity analyses for Opening Year traffic conditions with development at study area intersections are summarized in Appendix A, Tables 1, 3, and 5. Projected traffic volumes at study area intersections are shown in Appendix C, Figure 5b for the Opening Year. The capacity analyses worksheets are provided in Appendix L.

## **HORIZON YEAR CONDITIONS WITH DEVELOPMENT**

Traffic analyses conducted for conditions with the development are documented in this report section. The 2029 Horizon Year was analyzed.

### **Volumes and Capacity Analysis**

Capacity and queue analyses were completed using Synchro Software, Version 11.1, Build 2, Revision 9. The traffic signal timings that were optimized for No Build conditions were utilized for Build conditions. Capacity analyses for Horizon Year traffic conditions with development at study area intersections are summarized in Appendix A, Table 1. Projected traffic volumes at study area intersections are shown in Appendix D, Figure 6b for the Horizon Year. The capacity analyses worksheets are provided in Appendix L.

### **Traffic Signal Warrant Analyses**

Traffic signal warrant analyses were performed for the intersection of SR 0230/ Norlanco Drive Extension. The analyses indicate that the peak hour volume warrant is justified during the 2024 Opening Year with the proposed development traffic. The analyses are provided in Appendix O.

### **Queue Analysis**

Queue analyses were performed for the study intersections using the traffic volumes for the 2029 Horizon Year. The analyses provided recommendations for proposed turning lanes and assessed whether existing storage lanes for turning movements are adequate to accommodate the additional traffic generated by the proposed development. The results of the queue analyses are presented in Appendix A, Table 2. Queue analyses worksheets are provided with the capacity analyses worksheets in Appendix L.

## Left Turn Lane Analyses

The 2029 Horizon Year traffic volumes were analyzed to determine whether PennDOT guidelines for left turn lanes may be satisfied along SR 0230 and Cloverleaf Road at the proposed site access locations. The analyses indicated the following:

SR 0230/Norlanco Drive Extension: 250-foot eastbound left turn lane is warranted

Cloverleaf Rd/Andrew Avenue: 150-foot northbound left turn lane is warranted

Cloverleaf Rd/Andrew Avenue: 275-foot southbound left turn lane is warranted

The figures used in the left turn lane analyses are included in Appendix M.

## Right Turn Lane Analyses

The 2029 Horizon Year traffic volumes were analyzed to determine whether PennDOT guidelines for right turn lanes may be satisfied along SR 0230 and Cloverleaf Road at the proposed site access locations. The analyses indicated the following:

SR 0230/Right-In Access: 150-foot westbound right turn lane is warranted

SR 0230/Norlanco Drive Extension: 175-foot westbound right turn lane is warranted

Cloverleaf Rd/Right-In Access: 150-foot northbound right turn lane is warranted

Cloverleaf Rd/Eastern Parcels Access: 150-foot northbound right turn lane is warranted

The figures used in the right turn lane analyses are included in Appendix M.

## MITIGATION IDENTIFICATION AND RECOMMENDATIONS

The recommended improvements for off-site intersections are documented in this report section.

SR 0230/Cloverleaf Road - traffic signal timing adjustments in PM peak hour

Colebrook Road/Harrisburg Avenue - traffic signal installation

Colebrook Road/Andrew Avenue - northbound and southbound left turn lanes

Cloverleaf Road/Schwanger Road - traffic signal timing adjustments in PM peak hour



## **Alternative Transportation Plan**

No Alternative Transportation Plan is proposed.

## **CONCLUSIONS AND RECOMMENDATIONS**

The conclusions and recommendations are documented in the Executive Summary of the study report.

# APPENDICES

# **APPENDIX A**

## **SUMMARY OF RESULTS**

Table 1. Levels of Service Summary

Intersection Approach Movement	Highway Capacity Analyses Results																				
	LOS (delay)																				
	AM Peak Hour							PM Peak Hour							Saturday Peak Hour						
	2022	2024			2029			2022	2024			2029			2022	2024			2029		
	Base Year	No Build	Build	With Imp	No Build	Build	With Imp	Base Year	No Build	Build	With Imp	No Build	Build	With Imp	Base Year	No Build	Build	With Imp	No Build	Build	With Imp
<b>SR 0230 (S. Market Street) and SR 0743 (Maytown Avenue)</b>																					
SR 0230 - EB	B	B	C	---	B	C	---	C	C	D	---	C	D	---	B	B	B	---	B	B	---
SR 0230 - WB	A	A	A	---	A	A	---	A	A	A	---	A	A	---	B	A	B	---	A	B	---
WB Left	A	A	B	---	A	B	---	B	B	C	---	B	C	---	A	A	B	---	B	B	---
WB Thru	A	A	A	---	A	A	---	A	A	A	---	A	A	---	B	A	B	---	A	B	---
SR 0743 - NB	D	D	D	---	D	D	---	D	D	D	---	D	D	---	E	E	E	---	E	E	---
<b>Overall Intersection</b>	<b>B</b>	<b>B</b>	<b>B</b>	<b>---</b>	<b>B</b>	<b>B</b>	<b>---</b>	<b>B</b>	<b>C</b>	<b>C</b>	<b>---</b>	<b>C</b>	<b>C</b>	<b>---</b>	<b>C</b>	<b>B 17</b>	<b>C 21</b>	<b>---</b>	<b>B 18</b>	<b>C 22</b>	<b>---</b>
<b>SR 0230 and Groff Avenue</b>																					
SR 0230 - EB	A	A	A	---	A	A	---	A	A	A	---	A	A	---	A	A	A	---	A	A	---
SR 0230 - WB	A	A	A	---	A	A	---	A	A	A	---	A	A	---	A	A	A	---	A	A	---
Driveway - NB	B	B	B	---	B	B	---	E	E	E	---	E	E	---	B	B	B	---	B	C	---
Groff Avenue - SB	C	C	D	---	C	D	---	E	F 52	F 88	---	F 61	F 90	---	F 50	F 54	F 104	---	F 62	F 125	---
SB Left	D	D	E	---	D	E	---	F 92	F 106	F 171	---	F 127	F 188	---	F 76	F 82	F 157	---	F 95	F 192	---
SB Right	B	B	B	---	B	B	---	C	C	C	---	C	C	---	C	C	C	---	C	C	---
<b>Overall Intersection</b>	<b>A</b>	<b>A</b>	<b>A</b>	<b>---</b>	<b>A</b>	<b>A</b>	<b>---</b>	<b>A</b>	<b>A</b>	<b>A</b>	<b>---</b>	<b>A</b>	<b>A</b>	<b>A</b>	<b>A</b>	<b>A</b>	<b>A</b>	<b>---</b>	<b>A</b>	<b>A</b>	<b>---</b>

Intersection Approach Movement	Highway Capacity Analyses Results																				
	LOS (delay)																				
	AM Peak Hour							PM Peak Hour							Saturday Peak Hour						
	2022	2024			2029			2022	2024			2029			2022	2024			2029		
	Base Year	No Build	Build	With Imp	No Build	Build	With Imp	Base Year	No Build	Build	With Imp	No Build	Build	With Imp	Base Year	No Build	Build	With Imp	No Build	Build	With Imp
<b>SR 0230 and Giant Plaza Driveway/Carey Lane</b>																					
SR 0230 - EB	A	A	A	---	A	A	---	A	A	A	---	A	A	---	A	A	A	---	A	A	---
EB Left	A	A	A	---	A	A	---	A	A	A	---	A	A	---	A	A	A	---	A	A	---
EB Thru	A	A	A	---	A	A	---	A	A	A	---	A	A	---	A	A	A	---	A	A	---
EB Right	A	A	A	---	A	A	---	A	A	A	---	A	A	---	A	A	A	---	A	A	---
SR 0230 - WB	A	A	A	---	A	A	---	A	A	A	---	A	A	---	A	A	A	---	A	A	---
WB Left	A	A	A	---	A	A	---	A	A	A	---	A	A	---	A	A	A	---	A	A	---
WB Thru	A	A	A	---	A	A	---	A	A	A	---	A	A	---	A	A	A	---	A	A	---
WB Right	A	A	A	---	A	A	---	A	A	A	---	A	A	---	A	A	A	---	A	A	---
Giant Plaza Dr - NB	C	C	C	---	C	C	---	C	C	C	---	C	C	---	D	D	D	---	D	D	---
NB Left	C	C	C	---	C	C	---	C	C	C	---	C	C	---	D	D	D	---	D	D	---
NB Thru/Right	C	C	C	---	C	C	---	C	C	C	---	C	C	---	D	D	D	---	D	D	---
Carey Lane - SB	C	C	C	---	C	C	---	C	C	C	---	C	C	---	D	D	D	---	D	D	---
SB Left	C	C	C	---	C	C	---	C	C	C	---	C	C	---	D	D	D	---	D	D	---
SB Thru/Right	C	C	C	---	C	C	---	C	C	C	---	C	C	---	D	C	C	---	C	C	---
<b>Overall Intersection</b>	<b>A</b>	<b>A</b>	<b>A</b>	<b>---</b>	<b>A</b>	<b>A</b>	<b>---</b>	<b>A</b>	<b>A</b>	<b>A</b>	<b>---</b>	<b>A</b>	<b>A</b>	<b>---</b>	<b>B</b>	<b>B</b>	<b>B</b>	<b>---</b>	<b>B</b>	<b>B</b>	<b>---</b>

Intersection Approach Movement	Highway Capacity Analyses Results																				
	LOS (delay)																				
	AM Peak Hour							PM Peak Hour							Saturday Peak Hour						
	2022	2024			2029			2022	2024			2029			2022	2024			2029		
	Base Year	No Build	Build	With Imp	No Build	Build	With Imp	Base Year	No Build	Build	With Imp	No Build	Build	With Imp	Base Year	No Build	Build	With Imp	No Build	Build	With Imp
<b>SR 0230 and Market Street Square Driveway</b>																					
SR 0230 - EB	A	A	A	---	A	A	---	A	A	A	---	A	A	---	A	A	A	---	A	A	---
EB Left	A	A	A	---	A	A	---	A	A	A	---	A	A	---	A	A	A	---	A	A	---
EB Thru/Right	A	A	A	---	A	A	---	A	A	A	---	A	A	---	A	A	A	---	A	A	---
SR 0230 - WB	A	A	A	---	A	A	---	A	A	A	---	A	A	---	A	A	A	---	A	A	---
WB Left	A	A	A	---	A	A	---	A	A	A	---	A	A	---	A	A	A	---	A	A	---
WB Thru	A	A	A	---	A	A	---	A	A	A	---	A	A	---	A	A	A	---	A	A	---
WB Right	A	A	A	---	A	A	---	A	A	A	---	A	A	---	A	A	A	---	A	A	---
Hess Driveway - NB	D	D	D	---	D	D	---	D	D	D	---	C	C	---	D	D	D	---	D	D	---
Market St Sq Dr - SB	C	C	C	---	C	C	---	D	D	D	---	D	D	---	D	D	D	---	D	D	---
SB Left	C	C	C	---	C	C	---	D	D	D	---	D	D	---	D	D	D	---	D	D	---
SB Thru/Right	A	A	A	---	A	A	---	D	D	D	---	D	D	---	D	D	D	---	D	D	---
<b>Overall Intersection</b>	<b>A</b>	<b>A</b>	<b>A</b>	<b>---</b>	<b>A</b>	<b>A</b>	<b>---</b>	<b>A</b>	<b>A</b>	<b>A</b>	<b>---</b>	<b>A</b>	<b>A</b>	<b>---</b>	<b>A</b>	<b>A</b>	<b>A</b>	<b>---</b>	<b>A</b>	<b>A</b>	<b>---</b>

Intersection Approach Movement	Highway Capacity Analyses Results																				
	LOS (delay)																				
	AM Peak Hour							PM Peak Hour							Saturday Peak Hour						
	2022	2024			2029			2022	2024			2029			2022	2024			2029		
	Base Year	No Build	Build	With Imp	No Build	Build	With Imp	Base Year	No Build	Build	With Imp	No Build	Build	With Imp	Base Year	No Build	Build	With Imp	No Build	Build	With Imp
<b>SR 0230 and Sheaffer Road</b>																					
SR 0230 - EB	A	A	A	---	A	A	---	A	A	A	---	A	A	---	A	A	A	---	A	A	---
EB Left	A	A	A	---	A	A	---	A	A	A	---	A	A	---	A	A	A	---	A	A	---
EB Thru/Right	A	A	A	---	A	A	---	A	A	A	---	A	A	---	A	A	A	---	A	A	---
SR 0230 - WB	A	A	A	---	A	A	---	A	A	A	---	A	A	---	A	A	A	---	A	A	---
WB Left	A	A	A	---	A	A	---	A	A	A	---	A	A	---	A	A	A	---	A	A	---
WB Thru/Right	A	A	A	---	A	A	---	A	A	A	---	A	A	---	A	A	A	---	A	A	---
Sheaffer Road - NB	C	C	C	---	C	C	---	C	C	C	---	C	C	---	D	D	D	---	D	D	---
NB Left	C	C	C	---	C	C	---	C	C	C	---	C	C	---	D	D	D	---	D	D	---
NB Thru/Right	C	C	C	---	C	C	---	C	C	C	---	C	C	---	D	D	D	---	D	D	---
Sheaffer Road - SB	C	C	C	---	C	C	---	D	D	D	---	D	D	---	D	D	D	---	D	D	---
<b>Overall Intersection</b>	<b>A</b>	<b>A</b>	<b>A</b>	<b>---</b>	<b>A</b>	<b>A</b>	<b>---</b>	<b>A</b>	<b>A</b>	<b>A</b>	<b>---</b>	<b>A</b>	<b>A</b>	<b>---</b>	<b>A</b>	<b>A</b>	<b>A</b>	<b>---</b>	<b>A</b>	<b>A</b>	<b>---</b>

Intersection Approach Movement	Highway Capacity Analyses Results																				
	LOS (delay)																				
	AM Peak Hour							PM Peak Hour							Saturday Peak Hour						
	2022	2024			2029			2022	2024			2029			2022	2024			2029		
	Base Year	No Build	Build	With Imp	No Build	Build	With Imp	Base Year	No Build	Build	With Imp	No Build	Build	With Imp	Base Year	No Build	Build	With Imp	No Build	Build	With Imp
<b>SR 0230 and SR 4025 (Cloverleaf Road/Colebrook Road)</b>																					
SR 0230 - EB	B	B	C	---	B	C	---	C	C	C	C	C	C	C	B	B	B	---	B	B	---
EB Left	B	C	C	---	C	C	---	D	D	D	D	D	D	D	B	B	C	---	B	C	---
EB Thru	B	B	B	---	B	B	---	C	C	C	C	C	C	C	B	B	B	---	B	B	---
EB Right	B	B	B	---	B	B	---	C	C	B	B	C	C	B	A	A	A	---	A	B	---
SR 0230 - WB	C	C	C	---	C	C	---	D	D	D	D	D	D	D	C	C	D	---	C	D	---
WB Left	C	C	C	---	C	C	---	D	D	D	D	D	D	D	B	B	C	---	B	C	---
WB Thru	C	C	C	---	C	C	---	D	D	E	D	D	E	D	C	C	D	---	C	D	---
WB Right	A	A	A	---	A	A	---	A	A	A	A	A	A	A	A	A	A	---	A	A	---
SR 4025 - NB	C	C	C	---	C	C	---	C	C	D	C	C	C	C	C	C	C	---	C	C	---
NB Left	B	B	B	---	B	B	---	C	C	C	C	C	C	C	B	B	C	---	B	C	---
NB Thru/Right	C	C	C	---	C	D	---	C	C	D	D	C	D	D	C	C	C	---	C	C	---
SR 4025 - SB	C	C	C	---	C	C	---	B	B	C	D	C	C	D	C	C	C	---	C	C	---
SB Left	B	B	B	---	B	B	---	B	B	C	E	B	C	C	B	B	C	---	B	C	---
SB Thru	C	C	C	---	C	C	---	B	C	D	D	C	C	D	C	C	C	---	C	C	---
SB Right	C	C	C	---	C	C	---	B	B	C	D	C	C	D	C	C	C	---	C	C	---
<b>Overall Intersection</b>	<b>C</b>	<b>C</b>	<b>C</b>	<b>---</b>	<b>C</b>	<b>C</b>	<b>---</b>	<b>C</b>	<b>C</b>	<b>D</b>	<b>D</b>	<b>C</b>	<b>D</b>	<b>D</b>	<b>B</b>	<b>B</b>	<b>C</b>	<b>---</b>	<b>B</b>	<b>C</b>	<b>---</b>



Intersection Approach Movement		Highway Capacity Analyses Results																				
		LOS (delay)																				
		AM Peak Hour						PM Peak Hour						Saturday Peak Hour								
		2022	2024			2029			2022	2024			2029			2022	2024			2029		
		Base Year	No Build	Build	With Imp	No Build	Build	With Imp	Base Year	No Build	Build	With Imp	No Build	Build	With Imp	Base Year	No Build	Build	With Imp	No Build	Build	With Imp
<b>SR 0230 (W. Main Street) and Ridge Run Road</b>																						
SR 0230 - EB	A	A	A	---	A	A	---	A	A	A	---	A	A	---	A	A	A	---	A	A	---	
EB Left	A	A	A	---	A	A	---	A	A	A	---	A	A	---	A	A	A	---	A	A	---	
EB Thru/Right	A	A	A	---	A	A	---	A	A	A	---	A	A	---	A	A	A	---	A	A	---	
SR 0230 - WB	A	A	A	---	A	A	---	A	A	A	---	A	A	---	A	A	A	---	A	A	---	
Ridge Run Road - SB	B	B	B	---	B	B	---	B	B	C	---	B	C	---	B	B	B	---	B	B	---	
<b>Overall Intersection</b>	<b>A</b>	<b>A</b>	<b>A</b>	<b>---</b>	<b>A</b>	<b>A</b>	<b>---</b>	<b>A</b>	<b>A</b>	<b>A</b>	<b>---</b>	<b>A</b>	<b>A</b>	<b>---</b>	<b>A</b>	<b>A</b>	<b>A</b>	<b>---</b>	<b>A</b>	<b>A</b>	<b>---</b>	
<b>SR 4025 (Colebrook Road) and Harrisburg Avenue</b>																						
Harrisburg Ave - EB	B	B	B	A	B	B	A	C	C	C	B	C	C	B	A	A	A	A	A	B	A	
Harrisburg Ave - WB	B	B	B	A	B	B	B	B	B	B	B	B	B	B	A	A	A	A	A	A	A	
SR 4025 - NB	C	C	C	A	C	C	A	C	C	C	A	C	C	A	A	A	B	A	A	B	A	
SR 4025 - SB	B	B	C	A	B	C	A	D	D	F	A	E	F	A	A	A	B	A	A	B	A	
<b>Overall Intersection</b>	<b>B</b>	<b>B 14</b>	<b>C 16</b>	<b>A</b>	<b>B 14</b>	<b>C 17</b>	<b>A</b>	<b>C</b>	<b>C</b>	<b>E</b>	<b>A</b>	<b>D</b>	<b>D</b>	<b>A</b>	<b>A</b>	<b>A</b>	<b>B</b>	<b>A</b>	<b>A</b>	<b>B</b>	<b>A</b>	

Intersection Approach Movement	Highway Capacity Analyses Results																				
	LOS (delay)																				
	AM Peak Hour							PM Peak Hour							Saturday Peak Hour						
	2022	2024			2029			2022	2024			2029			2022	2024			2029		
	Base Year	No Build	Build	With Imp	No Build	Build	With Imp	Base Year	No Build	Build	With Imp	No Build	Build	With Imp	Base Year	No Build	Build	With Imp	No Build	Build	With Imp
<b>SR 4025 (Cloverleaf Road) and Andrew Avenue/Norlanco Drive</b>																					
Andrew Ave - EB	C	C	C	C	C	C	C	C	C	C	C	C	C	C	C	C	C	C	C	C	C
EB Left/Thru	C	C	C	C	C	C	C	C	C	C	C	C	C	C	C	C	C	C	C	C	C
EB Right	C	C	C	C	C	C	C	C	C	C	C	C	C	C	C	C	C	C	C	C	C
Norlanco Dr - WB	C	C	C	C	C	C	C	C	C	C	C	C	C	C	C	C	C	C	C	C	C
SR 4025 - NB	A	A	A	B	A	B	C	A	A	C	B	A	F	B	A	A	B	A	A	B	A
NB Left	---	---	---	A	---	---	A	---	---	---	A	---	---	A	---	---	---	A	---	---	A
NB Thru/Right	---	---	---	B	---	---	C	---	---	---	B	---	---	C	---	---	---	A	---	---	A
SR 4025 - SB	A	A	F	A	A	F	A	A	A	F	A	A	F	A	A	A	F	A	A	F	A
SB Left	A	A	F	B	A	F	B	A	A	F	A	A	F	B	A	A	F	A	A	F	A
SB Thru				A			A				A										
SB Right	A	A	A	A	A	A	A	A	A	A	A	A	A	A	A	A	A	A	A	A	A
<b>Overall Intersection</b>	<b>A</b>	<b>A</b>	<b>F</b>	<b>B</b>	<b>A</b>	<b>F</b>	<b>B</b>	<b>A</b>	<b>A</b>	<b>F</b>	<b>A</b>	<b>A</b>	<b>F</b>	<b>B</b>	<b>A</b>	<b>A</b>	<b>F</b>	<b>A</b>	<b>A</b>	<b>F</b>	<b>A</b>

Intersection Approach Movement	Highway Capacity Analyses Results																				
	LOS (delay)																				
	AM Peak Hour							PM Peak Hour							Saturday Peak Hour						
	2022	2024			2029			2022	2024			2029			2022	2024			2029		
	Base Year	No Build	Build	With Imp	No Build	Build	With Imp	Base Year	No Build	Build	With Imp	No Build	Build	With Imp	Base Year	No Build	Build	With Imp	No Build	Build	With Imp
<b>SR 4025 and Schwanger Road</b>																					
Schwanger Rd - EB	C	D	D	---	D	D	---	C	C	C	D	C	C	D	C	C	C	---	C	C	---
EB Left	C	D	D	---	D	D	---	C	C	C	E	C	C	E	C	C	C	---	C	C	---
EB Thru/Right	B	B	B	---	B	C	---	C	C	C	C	C	C	C	C	C	C	---	C	C	---
Schwanger Rd - WB	B	B	B	---	B	B	---	C	C	C	C	C	C	C	C	C	C	---	C	C	---
WB Left	C	C	C	---	C	C	---	C	C	C	C	C	C	C	C	C	C	---	C	C	---
WB Thru/Right	B	B	B	---	B	B	---	C	C	C	C	C	C	C	C	C	C	---	C	C	---
SR 4025 - NB	A	A	B	---	A	B	---	B	C	C	B	C	C	B	B	B	B	---	B	B	---
NB Left	A	A	B	---	A	B	---	D	E	E	E	E	E	E	B	B	C	---	B	C	---
NB Thru/Right	A	A	B	---	A	B	---	B	B	B	B	B	C	B	B	B	B	---	B	B	---
SR 4025 - SB	B	B	C	---	B	C	---	C	D	F	D	D	F	D	A	A	A	---	A	B	---
SB Left	A	A	A	---	A	A	---	B	B	B	B	B	C	B	B	B	B	---	B	B	---
SB Thru/Right	B	B	C	---	B	C	---	C	F	F	F	F	F	F	A	A	A	---	A	A	---
<b>Overall Intersection</b>	<b>B</b>	<b>B 18</b>	<b>C 23</b>	<b>---</b>	<b>B 20</b>	<b>C 26</b>	<b>---</b>	<b>C</b>	<b>C</b>	<b>E</b>	<b>D</b>	<b>D</b>	<b>E</b>	<b>D</b>	<b>B</b>	<b>B</b>	<b>B</b>	<b>---</b>	<b>B</b>	<b>B</b>	<b>---</b>
<b>SR 4025 and Merts Drive</b>																					
Merts Drive - EB	C	C	D	---	D	D	---	D	D	E	---	E	E	---	C	C	D	---	C	D	---
SR 4025 - NB	A	A	A	---	A	A	---	A	A	A	---	A	A	---	A	A	A	---	A	A	---
SR 4025 - SB	A	A	A	---	A	A	---	A	A	A	---	A	A	---	A	A	A	---	A	A	---
<b>Overall Intersection</b>	<b>A</b>	<b>A</b>	<b>A</b>	<b>---</b>	<b>A</b>	<b>A</b>	<b>---</b>	<b>A</b>	<b>A</b>	<b>A</b>	<b>---</b>	<b>A</b>	<b>A</b>	<b>---</b>	<b>A</b>	<b>A</b>	<b>A</b>	<b>---</b>	<b>A</b>	<b>A</b>	<b>---</b>

Intersection Approach Movement	Highway Capacity Analyses Results																				
	LOS (delay)																				
	AM Peak Hour							PM Peak Hour							Saturday Peak Hour						
	2022	2024			2029			2022	2024			2029			2022	2024			2029		
	Base Year	No Build	Build	With Imp	No Build	Build	With Imp	Base Year	No Build	Build	With Imp	No Build	Build	With Imp	Base Year	No Build	Build	With Imp	No Build	Build	With Imp
<b>SR 4025 and PA Route 283 EB Ramps</b>																					
PA 283 Off-Ramp - EB	C	C	C	---	C	C	---	F	F	F	---	F	F	---	B	B	C	---	B	C	---
EB Left	D	E	E	---	E	F	---	D	E	F	---	E	F	---	C	C	C	---	C	D	---
EB Right	B	B	C	---	B	C	---	F	F	F	---	F	F	---	B	B	C	---	B	C	---
SR 4025 - NB	A	A	A	---	A	A	---	A	A	A	---	A	A	---	A	A	A	---	A	A	---
SR 4025 - SB	A	A	A	---	A	A	---	A	A	A	---	A	A	---	A	A	A	---	A	A	---
SB Left	B	B	B	---	B	B	---	A	A	A	---	A	A	---	A	A	A	---	A	A	---
SB Thru	A	A	A	---	A	A	---	A	A	A	---	A	A	---	A	A	A	---	A	A	---
<b>Overall Intersection</b>	<b>A</b>	<b>A</b>	<b>A</b>	<b>---</b>	<b>A</b>	<b>A</b>	<b>---</b>	<b>B</b>	<b>C</b>	<b>E</b>	<b>---</b>	<b>D</b>	<b>E</b>	<b>---</b>	<b>A</b>	<b>A</b>	<b>A</b>	<b>---</b>	<b>A</b>	<b>A</b>	<b>---</b>
<b>SR 4025 and PA Route 283 WB Ramps</b>																					
PA 283 Off-Ramp - WB	C	C	C	---	C	C	---	C	C	C	---	C	C	---	B	B	C	---	B	C	---
WB Left/Thru	C	C	C	---	C	C	---	C	C	C	---	C	C	---	B	B	C	---	B	C	---
WB Right	A	A	A	---	A	A	---	A	A	A	---	A	A	---	A	A	A	---	A	A	---
SR 4025 - NB	B	B	C	---	B	C	---	B	B	C	---	B	C	---	A	A	A	---	A	A	---
NB Left	B	B	C	---	C	D	---	B	B	C	---	B	C	---	A	A	B	---	A	B	---
NB Thru	A	A	A	---	A	A	---	A	B	B	---	B	B	---	A	A	A	---	A	A	---
SR 4025 - SB	B	B	C	---	C	C	---	C	C	C	---	C	C	---	B	B	B	---	B	B	---
SB Thru	B	B	C	---	C	C	---	C	C	C	---	C	C	---	B	B	B	---	B	B	---
SB Right	A	A	A	---	A	A	---	A	A	A	---	A	A	---	A	A	A	---	A	A	---
<b>Overall Intersection</b>	<b>B</b>	<b>B 18</b>	<b>C 27</b>	<b>---</b>	<b>B 20</b>	<b>C 30</b>	<b>---</b>	<b>B</b>	<b>C</b>	<b>C</b>	<b>---</b>	<b>C</b>	<b>C</b>	<b>---</b>	<b>B</b>	<b>B</b>	<b>B</b>	<b>---</b>	<b>B</b>	<b>B</b>	<b>---</b>

Intersection Approach Movement		Highway Capacity Analyses Results																			
		LOS (delay)																			
		AM Peak Hour						PM Peak Hour						Saturday Peak Hour							
		2022	2024			2029			2022	2024			2029			2022	2024			2029	
		Base Year	No Build	Build	With Imp	No Build	Build	With Imp	Base Year	No Build	Build	With Imp	No Build	Build	With Imp	Base Year	No Build	Build	With Imp	No Build	Build
<b>SR 0230 and Proposed Access Drive</b>																					
SR 0230 - EB	---	---	A	A	---	A	A	---	---	A	A	---	A	A	---	---	A	A	---	A	A
EB Left	---	---	B	A	---	B	A	---	---	B	B	---	B	B	---	---	B	B	---	B	B
EB Thru	---	---	A	A	---	A	A	---	---	A	A	---	A	A	---	---	A	A	---	A	A
SR 0230 - WB	---	---	A	A	---	A	A	---	---	A	B	---	A	B	---	---	A	B	---	A	B
WB Thru	---	---	A	A	---	A	A	---	---	A	B	---	A	C	---	---	A	B	---	A	B
WB Right	---	---	A	A	---	A	A	---	---	A	B	---	A	B	---	---	A	B	---	A	B
Norlanco Drive - SB	---	---	C	C	---	C	C	---	---	F	D	---	F	D	---	---	F	C	---	F	C
SB Left	---	---		C	---		C	---	---		D	---		D	---	---		C	---		C
SB Right	---	---		C	---		C	---	---		D	---		D	---	---		C	---		C
<b>Overall Intersection</b>	---	---	<b>A</b>	<b>B</b>	---	<b>A</b>	<b>B</b>	---	---	<b>E</b>	<b>C</b>	---	<b>E</b>	<b>B</b>	---	---	<b>E</b>	<b>B</b>	---	<b>E</b>	<b>B</b>
<b>SR 4025 and Eastern Parcels Access</b>																					
Eastern Access - WB	---	---	C	---	---	D	---	---	---	C	---	---	C	---	---	---	C	---	---	C	---
SR 4025 - NB	---	---	A	---	---	A	---	---	---	A	---	---	A	---	---	---	A	---	---	A	---
SR 4025 - SB	---	---	A	---	---	A	---	---	---	A	---	---	A	---	---	---	A	---	---	A	---
<b>Overall Intersection</b>	---	---	<b>A</b>	---	---	<b>A</b>	---	---	---	<b>A</b>	---	---	<b>A</b>	---	---	---	<b>A</b>	---	---	<b>A</b>	---

Table 2. Queue Analysis Summary

Intersection Movement	Queue Analysis Results									
	95 <sup>th</sup> Percentile Queue (feet) - Synchro/HCM									
	Available Storage	AM 2029			PM 2029			Saturday 2029		
No Build		Build	Build w/ Imp.	No Build	Build	Build w/ Imp.	No Build	Build	Build w/ Imp.	
<b>SR 0230 (S. Market Street) and SR 0743 (Maytown Avenue)</b>										
SR 0230 - EB	1,450	353 / 278	407 / 328	---	606 / 543	672 / 740	---	570 / 400	729 / 475	---
SR 0230 - WB Left	150	22 / 20	22 / 25	---	87 / 100	105 / 148	---	48 / 40	62 / 63	---
SR 0230 - WB Thru	2,100	81 / 13	83 / 13	---	154 / 15	156 / 18	---	250 / 180	320 / 400	---
SR 0743 - NB	1,400	250 / 265	266 / 275	---	265 / 278	283 / 290	---	205 / 278	217 / 293	---
<b>SR 0230 (S. Market Street) and Groff Avenue</b>										
SR 0230 - EB Left	925	NA / 3	NA / 3	---	NA / 5	NA / 5	---	NA / 3	NA / 3	---
Groff Avenue - SB Left	500	NA / 28	NA / 38	---	NA / 55	NA / 83	---	NA / 68	NA / 110	---
Groff Avenue - SB Right	75	NA / 8	NA / 8	---	NA / 15	NA / 18	---	NA / 8	NA / 10	---
<b>SR 0230 and Giant Plaza Driveway/Carey Lane</b>										
SR 0230 - EB Left	200	1 / 0	1 / 0	---	5 / 0	5 / 0	---	15 / 0	15 / 0	---
SR 0230 - EB Thru	2,100	117 / 20	124 / 25	---	183 / 50	220 / 70	---	305 / 25	376 / 33	---
SR 0230 - EB Right	150	0 / 0	0 / 0	---	0 / 0	0 / 0	---	6 / 0	5 / 0	---
SR 0230 - WB Left	250	2 / 8	1 / 8	---	34 / 40	54 / 40	---	47 / 53	87 / 53	---
SR 0230 - WB Thru	1,225	11 / 18	12 / 20	---	62 / 43	80 / 55	---	227 / 25	297 / 33	---
SR 0230 - WB Right	100	0 / 0	0 / 0	---	0 / 0	0 / 0	---	1 / 0	1 / 0	---
Giant Plaza Dr - NB Left	200	95 / 85	95 / 85	---	284 / 235	284 / 235	---	341 / 310	341 / 310	---
Giant Plaza Dr - NB Thru/Right	200	35 / 33	35 / 33	---	42 / 63	42 / 63	---	57 / 118	57 / 118	---
Carey Lane - SB Left	100	9 / 3	9 / 3	---	29 / 18	29 / 18	---	50 / 40	50 / 40	---
Carey Lane - SB Thru/Right	150	10 / 3	10 / 3	---	22 / 15	22 / 15	---	22 / 13	22 / 13	---

Intersection Movement	Queue Analysis Results									
	95 <sup>th</sup> Percentile Queue (feet) - Synchro/HCM									
	Available Storage	AM 2029			PM 2029			Saturday 2029		
		No Build	Build	Build w/ Imp.	No Build	Build	Build w/ Imp.	No Build	Build	Build w/ Imp.
<b>SR 0230 and Market Street Square Driveway</b>										
SR 0230 - EB Left	275	2 / 0	1 / 0	---	17 / 8	16 / 8	---	31 / 18	36 / 18	---
SR 0230 - EB Thru/Right	1,225	66 / 10	85 / 13	---	207 / 8	253 / 8	---	188 / 13	254 / 13	---
SR 0230 - WB Left	225	2 / 0	1 / 0	---	2 / 0	2 / 0	---	3 / 0	2 / 0	---
SR 0230 - WB Thru	500	167 / 15	181 / 18	---	407 / 25	608 / 30	---	468 / 20	558 / 25	---
SR 0230 - WB Right	225	0 / 0	0 / 0	---	1 / 0	1 / 0	---	9 / 0	7 / 0	---
Hess Driveway - NB	50	0 / 20	0 / 20	---	19 / 10	19 / 20	---	33 / 25	33 / 25	---
Market St Sq Dr - SB Left	300	13 / 5	13 / 5	---	50 / 38	50 / 38	---	87 / 83	87 / 83	---
Market St Sq Dr - SB Thru/Right	300	0 / 0	0 / 0	---	46 / 65	46 / 65	---	98 / 148	98 / 148	---
<b>SR 0230 and Sheaffer Road</b>										
SR 0230 - EB Left	125	3 / 3	3 / 3	---	3 / 5	2 / 10	---	30 / 3	29 / 3	---
SR 0230 - EB Thru/Right	500	17 / 10	17 / 13	---	9 / 13	10 / 15	---	206 / 13	226 / 15	---
SR 0230 - WB Left	125	7 / 0	7 / 0	---	21 / 8	21 / 8	---	11 / 3	11 / 3	---
SR 0230 - WB Thru/Right	2,000+	151 / 50	174 / 58	---	353 / 160	438 / 190	---	209 / 80	263 / 100	---
Sheaffer Road - NB Left	75	56 / 48	56 / 48	---	89 / 83	89 / 83	---	95 / 90	95 / 90	---
Sheaffer Road - NB Thru/Right	275	40 / 33	40 / 33	---	45 / 40	45 / 40	---	47 / 38	47 / 38	---
Sheaffer Road - SB	2,000+	52 / 60	52 / 60	---	94 / 140	94 / 140	---	75 / 90	75 / 90	---

Intersection Movement		Queue Analysis Results								
		95 <sup>th</sup> Percentile Queue (feet) - Synchro/HCM								
		Available Storage	AM 2029			PM 2029			Saturday 2029	
No Build	Build		Build w/ Imp.	No Build	Build	Build w/ Imp.	No Build	Build	Build w/ Imp.	
<b>SR 0230 and SR 4025 (Cloverleaf Road/Colebrook Road)</b>										
SR 0230 - EB Left	275	211 / 155	265 / 210	---	160 / 228	230 / 228	226 / 258	125 / 75	192 / 118	---
SR 0230 - EB Thru	800	117 / 83	148 / 120	---	205 / 258	233 / 268	219 / 273	154 / 90	195 / 140	---
SR 0230 - EB Right	250	0 / 10	0 / 10	---	8 / 25	7 / 23	7 / 23	0 / 13	0 / 15	---
SR 0230 - WB Left	150	8 / 3	57 / 35	---	36 / 25	153 / 150	138 / 150	30 / 13	124 / 70	---
SR 0230 - WB Thru	1,125	147 / 118	219 / 193	---	312 / 360	519 / 550	459 / 530	259 / 183	415 / 383	---
SR 0230 - WB Right	125	43 / 0	43 / 0	---	36 / 0	34 / 0	15 / 0	0 / 0	0 / 0	---
SR 4025 - NB Left	100	47 / 40	47 / 40	---	85 / 80	90 / 93	94 / 88	44 / 38	44 / 43	---
SR 4025 - NB Thru/Right	850	354 / 275	419 / 338	---	326 / 290	468 / 393	468 / 360	129 / 113	167 / 183	---
SR 4025 - SB Left	325	66 / 55	66 / 58	---	157 / 158	146 / 205	142 / 213	73 / 60	73 / 70	---
SR 4025 - SB Thru	525	184 / 148	170 / 138	---	380 / 253	252 / 315	263 / 348	132 / 100	109 / 88	---
SR 4025 - SB Right	400	48 / 115	36 / 100	---	78 / 163	41 / 163	41 / 188	24 / 30	1 / 35	---
<b>SR 0230 (W. Main Street) and Ridge Run Road</b>										
SR 0230 - EB Left	TWLTL	NA / 0	NA / 0	---	NA / 0	NA / 0	---	NA / 0	NA / 0	---
Ridge Run Road - SB	1,000	NA / 5	NA / 5	---	NA / 8	NA / 10	---	NA / 5	NA / 8	---
<b>SR 4025 (Colebrook Road) and Harrisburg Avenue</b>										
Harrisburg Avenue - EB	1,000+	NA / 23	NA / 28	74 / 20	NA / 73	NA / 88	177 / 63	NA / 18	NA / 20	50 / 15
Harrisburg Avenue - WB	1,000+	NA / 28	NA / 33	53 / 30	NA / 23	NA / 28	51 / 28	NA / 13	NA / 15	34 / 13
SR 4025 - NB	1,000+	NA / 98	NA / 128	168 / 58	NA / 93	NA / 130	122 / 60	NA / 30	NA / 43	75 / 25
SR 4025 - SB	850	NA / 60	NA / 78	114 / 40	NA / 228	NA / 355	269 / 108	NA / 35	NA / 55	90 / 30



Intersection Movement	Queue Analysis Results									
	95 <sup>th</sup> Percentile Queue (feet) - Synchro/HCM									
	Available Storage	AM 2029			PM 2029			Saturday 2029		
		No Build	Build	Build w/ Imp.	No Build	Build	Build w/ Imp.	No Build	Build	Build w/ Imp.
<b>SR 4025 (Cloverleaf Road) and Andrew Avenue/Norlanco Drive</b>										
Andrew Avenue - EB Left/Thru	1,000+	40 / 30	40 / 30	42 / 30	19 / 10	19 / 10	20 / 10	11 / 5	11 / 5	13 / 5
Andrew Avenue - EB Right	125	5 / 13	5 / 13	0 / 13	4 / 8	4 / 8	0 / 8	0 / 5	0 / 5	0 / 5
Norlanco Drive - WB	1,000+	28 / 23	28 / 23	30 / 23	55 / 60	53 / 60	17 / 60	13 / 20	13 / 20	0 / 23
SR 4025 - NB Left	(150)	---	---	3 / 0	---	---	10 / 3	---	---	12 / 3
SR 4025 - NB Thru/Right	1,200	338 / 100	566 / 258	666 / 395	204 / 23	287 / 425	715 / 263	110 / 25	194 / 280	454 / 220
SR 4025 - SB Left	(275)	---	---	64 / 70	---	---	68 / 55	---	---	60 / 53
SR 4025 - SB Thru	1,100	261 / 8	413 / 1893	135 / 3	29 / 5	449 / 3315	141 / 3	13 / 10	522 / 2058	80 / 10
SR 4025 - SB Right	100	0 / 0	0 / 0	0 / 0	0 / 0	0 / 0	0 / 0	0 / 0	0 / 0	0 / 0
<b>SR 4025 and Schwanger Road</b>										
Schwanger Road - EB Left	225	354 / 348	354 / 348	---	208 / 158	209 / 158	241 / 240	104 / 95	104 / 95	---
Schwanger Road - EB Thru/Right	1,000+	42 / 65	45 / 78	---	48 / 48	51 / 60	55 / 68	35 / 28	39 / 40	---
Schwanger Road - WB Left	75	13 / 5	13 / 5	---	13 / 5	13 / 5	14 / 5	14 / 5	14 / 5	---
Schwanger Road - WB Thru/Right	1,000+	36 / 53	36 / 53	---	44 / 35	44 / 35	48 / 38	30 / 23	30 / 23	---
SR 4025 - NB Left	75	10 / 13	11 / 28	---	43 / 63	61 / 88	75 / 83	15 / 20	18 / 38	---
SR 4025 - NB Thru/Right	1,100	592 / 100	690 / 188	---	300 / 330	364 / 403	258 / 285	205 / 273	336 / 363	---
SR 4025 - SB Left	100	9 / 3	10 / 3	---	19 / 23	21 / 30	15 / 23	11 / 8	11 / 10	---
SR 4025 - SB Thru/Right	1,500+	455 / 323	605 / 463	---	754 / 805	882 / 1375	836 / 840	230 / 138	458 / 213	---
<b>SR 4025 and Merts Drive</b>										
Merts Drive - EB	1,000	NA / 15	NA / 20	---	NA / 8	NA / 10	---	NA / 3	NA / 8	---
SR 4025 - NB	1,500+	NA / 0	NA / 0	---	NA / 3	NA / 3	---	NA / 5	NA / 3	---
<b>SR 4025 and PA Route 283 EB Ramps</b>										
PA 283 Off-Ramp - EB Left	325	NA / 25	NA / 33	---	NA / 35	NA / 50	---	NA / 8	NA / 10	---
PA 283 Off-Ramp - EB Right	1,000	NA / 48	NA / 75	---	NA / 453	NA / 698	---	NA / 35	NA / 70	---
SR 4025 - SB Left	75	NA / 15	NA / 15	---	NA / 10	NA / 10	---	NA 8	NA / 10	---

Intersection Movement	Queue Analysis Results									
	95 <sup>th</sup> Percentile Queue (feet) - Synchro/HCM									
	Available Storage	AM 2029			PM 2029			Saturday 2029		
No Build		Build	Build w/ Imp.	No Build	Build	Build w/ Imp.	No Build	Build	Build w/ Imp.	
<b>SR 4025 and PA Route 283 WB Ramps</b>										
PA 283 Off-Ramp - WB Left/Thru	1,000	241 / 193	302 / 248	---	420 / 340	492 / 435	---	189 / 165	291 / 230	---
PA 283 Off-Ramp - WB Right	400	9 / 0	9 / 0	---	24 / 0	24 / 0	---	0 / 0	0 / 0	---
SR 4025 - NB Left	200	371 / 215	406 / 335	---	149 / 123	228 / 215	---	80 / 45	104 / 78	---
SR 4025 - NB Thru	400	46 / 25	50 / 33	---	68 / 48	77 / 63	---	46 / 20	55 / 33	---
SR 4025 - SB Thru	1,000+	113 / 95	125 / 115	---	149 / 143	163 / 175	---	77 / 48	91 / 70	---
SR 4025 - SB Right	75	0 / 0	0 / 0	---	0 / 0	0 / 0	---	0 / 0	0 / 0	---
<b>SR 0230 and Proposed Access Drive</b>										
SR 0230 - EB Left	(350)	---	NA / 15	31 / 20	---	NA / 25	31 / 78	---	NA / 33	61 / 55
SR 0230 - EB Thru/Right	1,125	---	NA / 0	80 / 50	---	NA / 0	110 / 18	---	NA / 0	128 / 110
SR 0230 - WB Thru	2,000+	---	NA / 0	212 / 150	---	NA / 0	356 / 350	---	NA / 0	291 / 263
SR 0230 - WB Right	(225)	---	NA / 0	16 / 15	---	NA / 0	26 / 50	---	NA / 0	24 / 40
Norlanco Drive - SB Left	(175)	---	NA / 53	69 / 58	---	NA / 535	185 / 188	---	NA / 493	123 / 115
Norlanco Drive - SB Thru/Right	(200)	---		37 / 125	---		187 / 380	---		84 / 230
<b>SR 4025 and Eastern Parcels Access</b>										
Eastern Access - WB	300	---	NA / 65	---	---	NA / 80	---	---	NA / 68	---

(XXX) Recommended turn lane length  
 TWLTL - Two-Way Center Left Turn Lane

# **APPENDIX B**

# **EXISTING CONDITIONS**

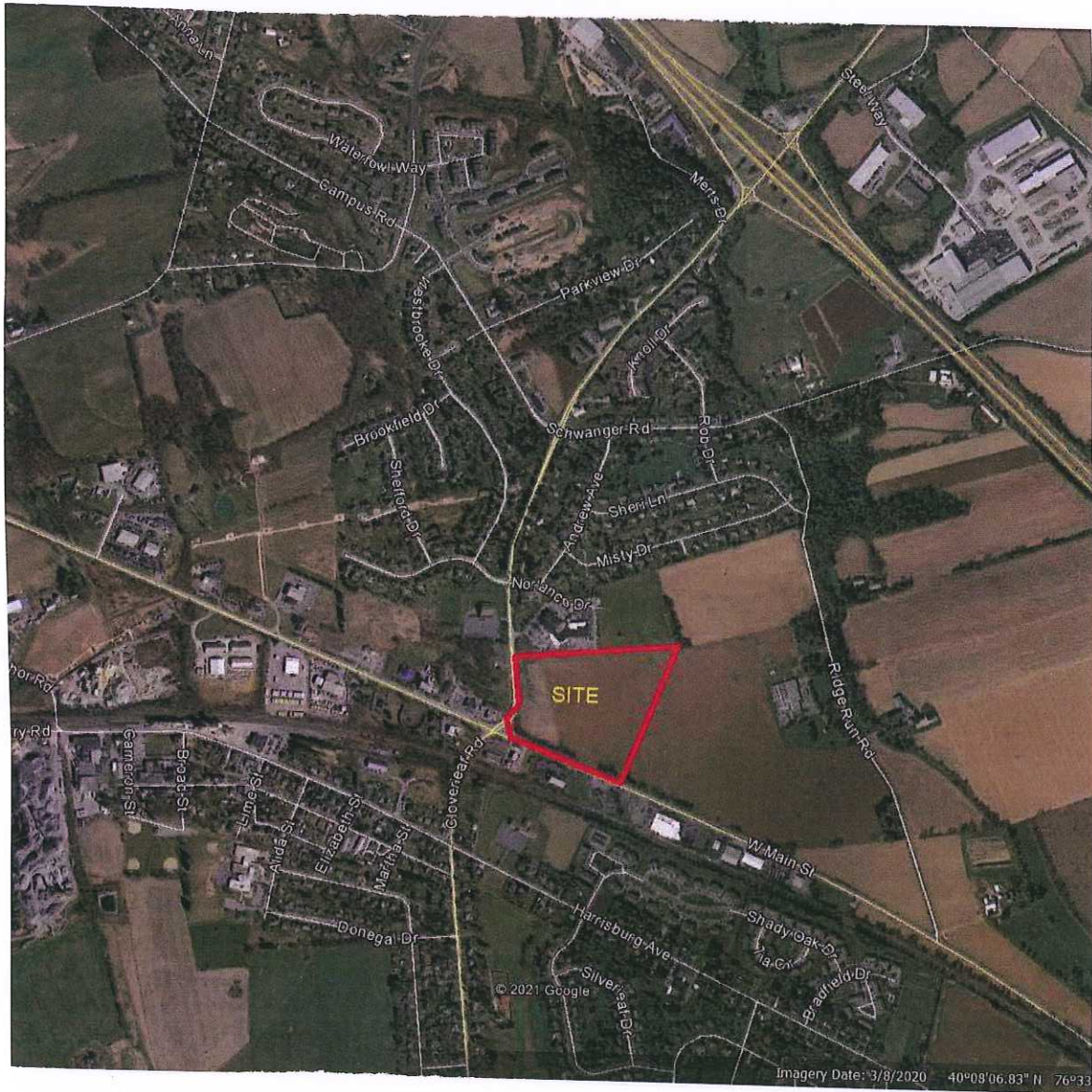

Transportation Impact Study

PENNMAR  
PROPERTY

Mount Joy Township, Lancaster County

FIGURE 1  
LOCATION MAP

# **FIGURE 2**

# **SITE PLAN**

FILENAME: P:\4939-C-1 Zoning Site Plan - Norlanco Drive.dwg XREFS: IMAGES: P:\4939-Tyson.Zoning.Hearing.Board\30002300PAS\_PEM\_2018\_02.rvt PLOTTED: March 30, 2023 @ 02:10PM

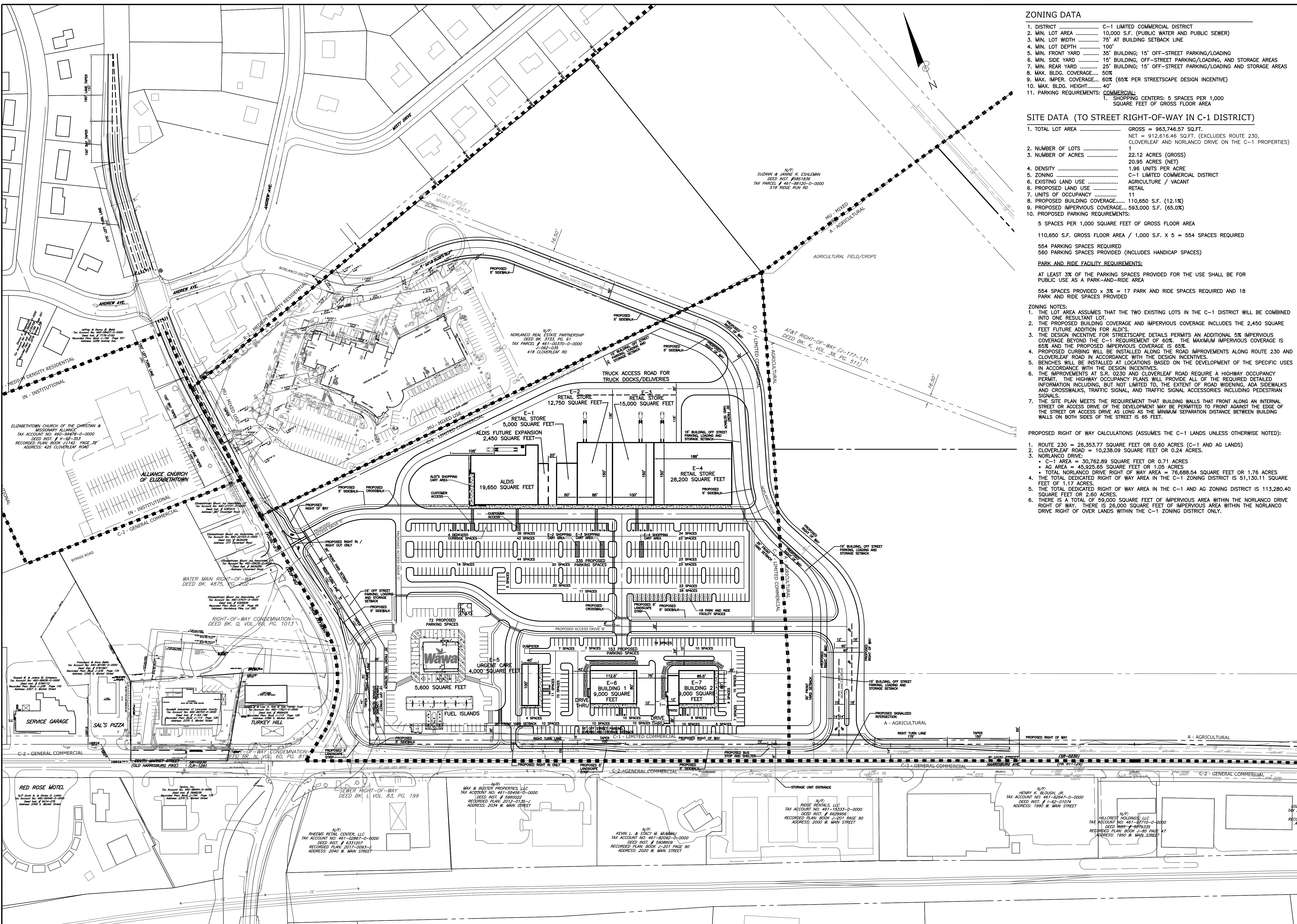

**ZONING DATA**

- DISTRICT ..... C-1 LIMITED COMMERCIAL DISTRICT
- MIN. LOT AREA ..... 10,000 S.F. (PUBLIC WATER AND PUBLIC SEWER)
- MIN. LOT WIDTH ..... 75' AT BUILDING SETBACK LINE
- MIN. LOT DEPTH ..... 100'
- MIN. FRONT YARD ..... 35' BUILDING; 15' OFF-STREET PARKING/LOADING
- MIN. SIDE YARD ..... 15' BUILDING; OFF-STREET PARKING/LOADING, AND STORAGE AREAS
- MIN. REAR YARD ..... 25' BUILDING; 15' OFF-STREET PARKING/LOADING AND STORAGE AREAS
- MAX. BLDG. COVERAGE ..... 50%
- MAX. IMPER. COVERAGE ..... 60% (65% PER STREETScape DESIGN INCENTIVE)
- MAX. BLDG. HEIGHT ..... 40'
- PARKING REQUIREMENTS: COMMERCIAL:
  - SHOPPING CENTERS: 5 SPACES PER 1,000 SQUARE FEET OF GROSS FLOOR AREA

**SITE DATA (TO STREET RIGHT-OF-WAY IN C-1 DISTRICT)**

- TOTAL LOT AREA ..... GROSS = 963,746.57 SQ.FT.  
NET = 912,616.46 SQ.FT. (EXCLUDES ROUTE 230, CLOVERLEAF AND NORLANCO DRIVE ON THE C-1 PROPERTIES)
- NUMBER OF LOTS ..... 1
- NUMBER OF ACRES ..... 22.12 ACRES (GROSS)  
20.95 ACRES (NET)
- DENSITY ..... 1.96 UNITS PER ACRE
- ZONING ..... C-1 LIMITED COMMERCIAL DISTRICT
- EXISTING LAND USE ..... AGRICULTURE / VACANT
- PROPOSED LAND USE ..... RETAIL
- UNITS OF OCCUPANCY ..... 11
- PROPOSED BUILDING COVERAGE ..... 110,650 S.F. (12.1%)
- PROPOSED IMPERVIOUS COVERAGE ..... 593,000 S.F. (65.0%)
- PROPOSED PARKING REQUIREMENTS:
  - 5 SPACES PER 1,000 SQUARE FEET OF GROSS FLOOR AREA

110,650 S.F. GROSS FLOOR AREA / 1,000 S.F. X 5 = 554 SPACES REQUIRED

554 PARKING SPACES REQUIRED  
560 PARKING SPACES PROVIDED (INCLUDES HANDICAP SPACES)

**PARK AND RIDE FACILITY REQUIREMENTS:**

AT LEAST 3% OF THE PARKING SPACES PROVIDED FOR THE USE SHALL BE FOR PUBLIC USE AS A PARK-AND-RIDE AREA

554 SPACES PROVIDED X 3% = 17 PARK AND RIDE SPACES REQUIRED AND 18 PARK AND RIDE SPACES PROVIDED

**ZONING NOTES:**

- THE LOT AREA ASSUMES THAT THE TWO EXISTING LOTS IN THE C-1 DISTRICT WILL BE COMBINED INTO ONE RESULTANT LOT.
- THE PROPOSED BUILDING COVERAGE AND IMPERVIOUS COVERAGE INCLUDES THE 2,450 SQUARE FEET FUTURE ADDITION FOR ALDIS.
- THE DESIGN INCENTIVE FOR STREETScape DETAILS PERMITS AN ADDITIONAL 5% IMPERVIOUS COVERAGE BEYOND THE C-1 REQUIREMENT OF 60%. THE MAXIMUM IMPERVIOUS COVERAGE IS 65% AND THE PROPOSED IMPERVIOUS COVERAGE IS 65%.
- PROPOSED CURBING WILL BE INSTALLED ALONG THE ROAD IMPROVEMENTS ALONG ROUTE 230 AND CLOVERLEAF ROAD IN ACCORDANCE WITH THE DESIGN INCENTIVES.
- BENCHES WILL BE INSTALLED AT LOCATIONS BASED ON THE DEVELOPMENT OF THE SPECIFIC USES IN ACCORDANCE WITH THE DESIGN INCENTIVES.
- THE IMPROVEMENTS AT S.R. 0230 AND CLOVERLEAF ROAD REQUIRE A HIGHWAY OCCUPANCY PERMIT. THE HIGHWAY OCCUPANCY PLANS WILL PROVIDE ALL OF THE REQUIRED DETAILED INFORMATION INCLUDING, BUT NOT LIMITED TO, THE EXTENT OF ROAD WIDENING, ADA SIDEWALKS AND CROSSWALKS, TRAFFIC SIGNAL, AND TRAFFIC SIGNAL ACCESSORIES INCLUDING PEDESTRIAN SIGNALS.
- THE SITE PLAN MEETS THE REQUIREMENT THAT BUILDING WALLS THAT FRONT ALONG AN INTERNAL STREET OR ACCESS DRIVE OF THE DEVELOPMENT MAY BE PERMITTED TO FRONT AGAINST THE EDGE OF THE STREET OR ACCESS DRIVE AS LONG AS THE MINIMUM SEPARATION DISTANCE BETWEEN BUILDING WALLS ON BOTH SIDES OF THE STREET IS 65 FEET.

**PROPOSED RIGHT OF WAY CALCULATIONS (ASSUMES THE C-1 LANDS UNLESS OTHERWISE NOTED):**

- ROUTE 230 = 26,353.77 SQUARE FEET OR 0.60 ACRES (C-1 AND AG LANDS)
- CLOVERLEAF ROAD = 10,238.09 SQUARE FEET OR 0.24 ACRES.
- NORLANCO DRIVE:
  - C-1 AREA = 30,762.89 SQUARE FEET OR 0.71 ACRES
  - AG AREA = 45,925.69 SQUARE FEET OR 1.05 ACRES
  - TOTAL NORLANCO DRIVE RIGHT OF WAY AREA = 76,688.54 SQUARE FEET OR 1.76 ACRES
- THE TOTAL DEDICATED RIGHT OF WAY AREA IN THE C-1 ZONING DISTRICT IS 51,130.11 SQUARE FEET OR 1.17 ACRES
- THE TOTAL DEDICATED RIGHT OF WAY AREA IN THE C-1 AND AG ZONING DISTRICT IS 113,280.40 SQUARE FEET OR 2.60 ACRES.
- THERE IS A TOTAL OF 59,000 SQUARE FEET OF IMPERVIOUS AREA WITHIN THE NORLANCO DRIVE RIGHT OF WAY. THERE IS 28,000 SQUARE FEET OF IMPERVIOUS AREA WITHIN THE NORLANCO DRIVE RIGHT OF WAY OVER LANDS WITHIN THE C-1 ZONING DISTRICT ONLY.

OWNERS: TRACT 1 AND TRACT 2	ELIZABETHTOWN ASSOCIATES
NAME: ELIZABETHTOWN MOUNT JOY ASSOCIATES, LP	1000 GERMANTOWN RD SUITE A - 2
ADDRESS: 1000 GERMANTOWN RD SUITE A - 2	PLYMOUTH MEETING, PA 19462
SOURCE OF TITLE: DEED INST. # 5160060	LANC. CO. TAX ACCT.: 461-41585-0-0000
NAME: ELIZABETHTOWN MOUNT JOY ASSOCIATES, LP	1000 GERMANTOWN RD SUITE A - 2
ADDRESS: 1000 GERMANTOWN RD SUITE A - 2	PLYMOUTH MEETING, PA 19462
SOURCE OF TITLE: DEED INST. # 5160061	LANC. CO. TAX ACCT.: 461-95417-0-0000

OWNERS: PREMISE A AND PREMISE B	ELIZABETHTOWN ASSOCIATES
NAME: ELIZABETHTOWN MOUNT JOY ASSOCIATES, LP	1000 GERMANTOWN RD SUITE A - 2
ADDRESS: 1000 GERMANTOWN RD SUITE A - 2	PLYMOUTH MEETING, PA 19462
SOURCE OF TITLE: DEED BK. U. VOL. 71, PG. 21	LANC. CO. TAX ACCT.: 461-00486-0-0000
NAME: ELIZABETHTOWN ASSOCIATES	1000 GERMANTOWN RD SUITE A - 2
ADDRESS: 1000 GERMANTOWN RD SUITE A - 2	PLYMOUTH MEETING, PA 19462
SOURCE OF TITLE: DEED BK. U. VOL. 71, PG. 21	LANC. CO. TAX ACCT.: 461-82176-0-0000

**dcjohn**  
Associates, Inc.

Surveyors - Engineers - Landscape Architects

32 Mount Joy Street  
Po Box 128  
Mount Joy, PA 17552  
Ph: (717) 653-5308  
www.dcgohm.com

PROJECT NO.: 4939-50
DATE: MARCH 30, 2023
DRAWN BY: BRC
CHECKED BY: BRC
SCALE: 1"=100'

**PROPOSED SITE PLAN**  
FOR  
**MOUNT JOY TOWN CENTER**

**PENMARK MANAGEMENT COMPANY**  
MOUNT JOY TOWNSHIP  
LANCASTER COUNTY, PENNSYLVANIA

DRAWING #: CG-2991A  
SHEET #: 1 OF 3

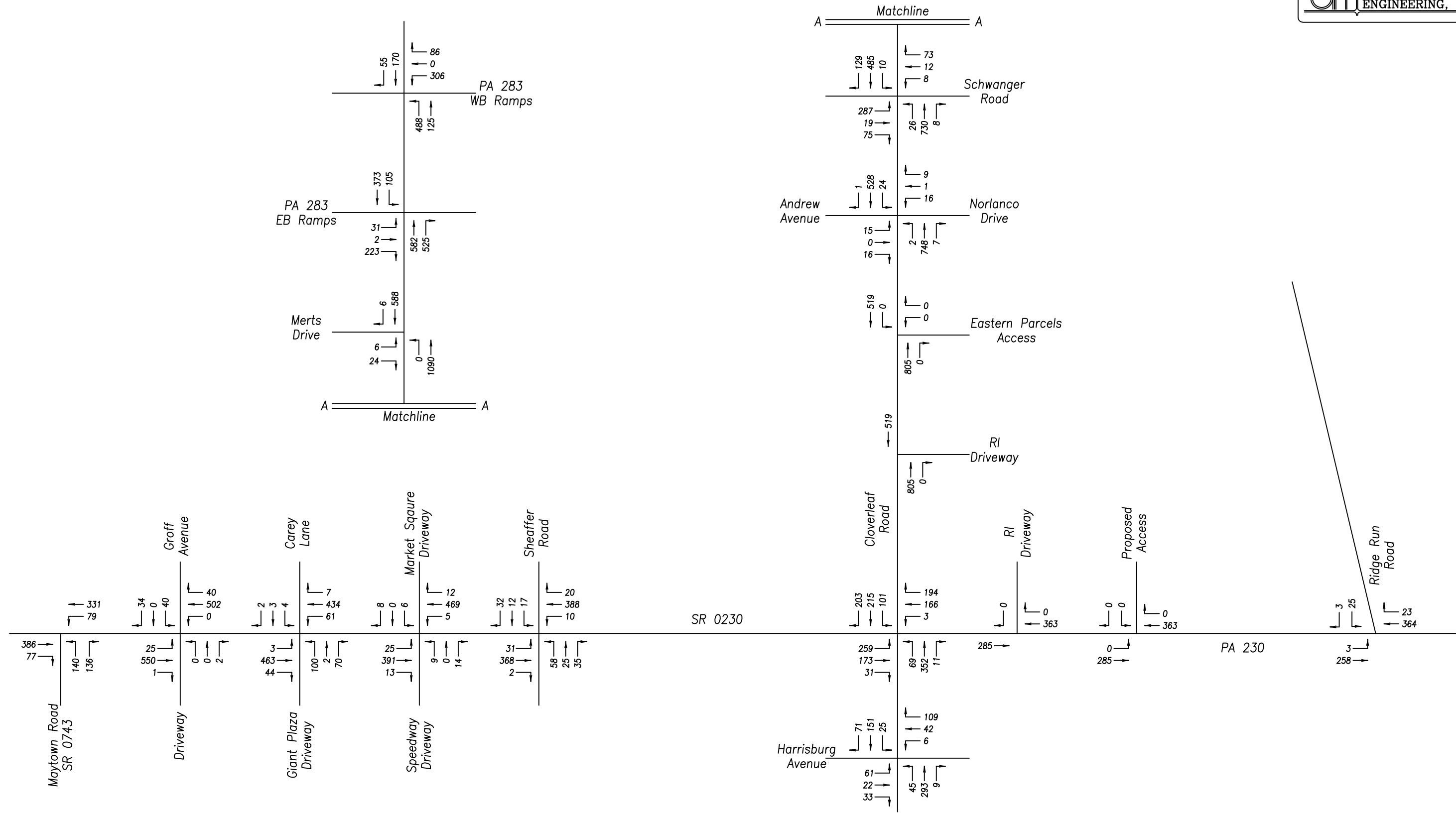

FIGURE 3a. EXISTING TRAFFIC VOLUMES, AM PEAK HOUR

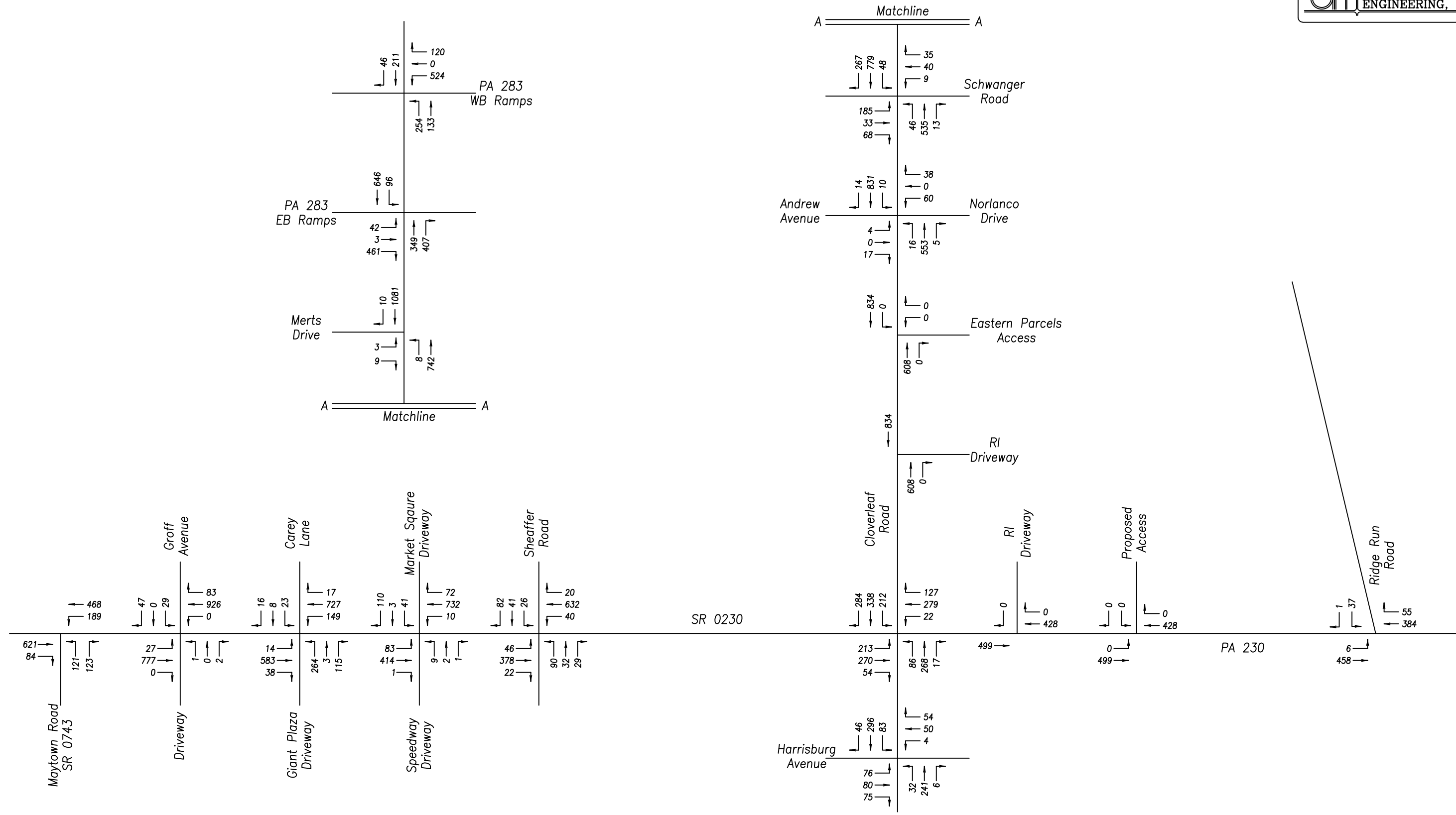
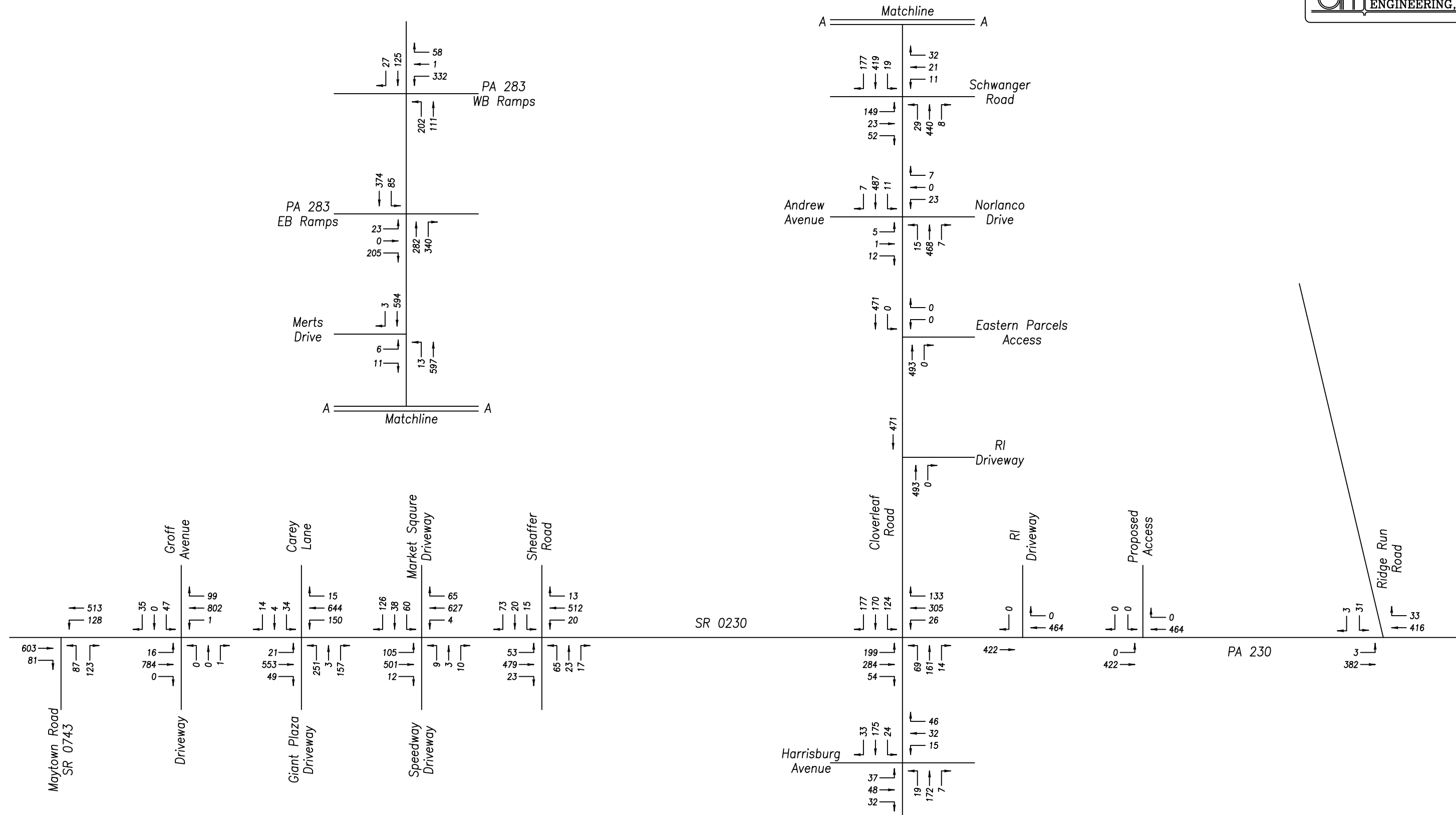

FIGURE 3b. EXISTING TRAFFIC VOLUMES, PM PEAK HOUR





**FIGURE 3c. EXISTING TRAFFIC VOLUMES, SATURDAY PEAK HOUR**

**FIGURE 3d**

**TRAFFIC SIGNAL PERMIT PLANS**

CYCLE / SPLIT / OFFSET

PROGRAM 1 = AM PEAK		PHASE 0000								CYCLE	OFFSET
INTERSECTIONS	FILE #	1	2	3	4	5	6	7	8		00
11 SOUTH MARKET STREET (SR 0230) & SHEAFFER ROAD	T-175		45		25		45		25	70	0
10 MARKET STREET (SR 0230) & MARKET STREET SQUARE DRIVEWAY	T-112	11(LEAD)	45		14		56		14	70	7
9 MARKET STREET (SR 0230) & CAREY LANE/COMMERCIAL DRIVEWAY	T-173	13(LEAD)	40		17		53		17	70	29
8 MARKET STREET (SR 0230) & MAYTOWN AVENUE (SR 0743)	B-054	12(LEAD)	34	24			46			70	61
7 MARKET STREET (SR 0230) & ARCH STREET	B-077		41		29		41			70	56
17 MARKET STREET (SR 0230) & COLLEGE AVENUE	B-093	10(LEAD)	35		25	10(LEAD)	35		25	70	22
6 MARKET STREET (SR 0230) & BAINBRIDGE STREET	B-053		43		27		43			70	28
5 MARKET STREET (SR 0230) & HIGH STREET (SR 0241/4008)	B-056	14(LEAD)	28		28	14(LEAD)	28		28	70	67
4 MARKET STREET (SR 0230) & WILLOW STREET	B-076		44		26		44		26	70	36
3 MARKET STREET (SR 0230) & LINDEN AVENUE (SR 0743/0241)	B-049		37	31	1		37	1		70	50
2 HERSHEY ROAD (SR 0743/0241), MOUNT GREINA ROAD (SR 0241), HOLLY STREET & TURKEY HILL DRIVEWAY	T-132									FREE	
1 HERSHEY ROAD (SR 0743) & PA 283 WB RAMP 0 (SR 8015)										FREE	
PROGRAM 2 = PM PEAK		PHASE 0000								CYCLE	OFFSET
INTERSECTIONS	FILE #	1	2	3	4	5	6	7	8		00
11 SOUTH MARKET STREET (SR 0230) & SHEAFFER ROAD	T-175		48		32		48		32	80	0
10 MARKET STREET (SR 0230) & MARKET STREET SQUARE DRIVEWAY	T-112	11(LEAD)	51		18		62		18	80	11
9 MARKET STREET (SR 0230) & CAREY LANE/COMMERCIAL DRIVEWAY	T-173	13(LEAD)	43		24		56		24	80	33
8 MARKET STREET (SR 0230) & MAYTOWN AVENUE (SR 0743)	B-054	12(LEAD)	46	22			58			80	5
7 MARKET STREET (SR 0230) & ARCH STREET	B-077		51		29		51			80	61
17 MARKET STREET (SR 0230) & COLLEGE AVENUE	B-093	12(LEAD)	38		30	12(LEAD)	38		30	80	41
6 MARKET STREET (SR 0230) & BAINBRIDGE STREET	B-053		47		27		47			80	44
5 MARKET STREET (SR 0230) & HIGH STREET (SR 0241/4008)	B-056	14(LEAD)	38		28	14(LEAD)	38		28	80	71
4 MARKET STREET (SR 0230) & WILLOW STREET	B-076		53		27		53		27	80	3
3 MARKET STREET (SR 0230) & LINDEN AVENUE (SR 0743/0241)	B-049		40	38	1		40	1		80	0
2 HERSHEY ROAD (SR 0743/0241), MOUNT GREINA ROAD (SR 0241), HOLLY STREET & TURKEY HILL DRIVEWAY	T-132									FREE	
1 HERSHEY ROAD (SR 0743) & PA 283 WB RAMP 0 (SR 8015)										FREE	
PROGRAM 3 = WEEKEND PEAK		PHASE 0000								CYCLE	OFFSET
INTERSECTIONS	FILE #	1	2	3	4	5	6	7	8		00
11 SOUTH MARKET STREET (SR 0230) & SHEAFFER ROAD	T-175		64		46		64		46	110	0
10 MARKET STREET (SR 0230) & MARKET STREET SQUARE DRIVEWAY	T-112	14(LEAD)	68		28		82		28	110	9
9 MARKET STREET (SR 0230) & CAREY LANE/COMMERCIAL DRIVEWAY	T-173	22(LEAD)	57		31		79		31	110	9
8 MARKET STREET (SR 0230) & MAYTOWN AVENUE (SR 0743)	B-054	12(LEAD)	69	29			81			110	97
7 MARKET STREET (SR 0230) & ARCH STREET	B-077		44		26		44			70	10
17 MARKET STREET (SR 0230) & COLLEGE AVENUE	B-093	10(LEAD)	40		20	10(LEAD)	40		20	70	65
6 MARKET STREET (SR 0230) & BAINBRIDGE STREET	B-053		43		27		43			70	3
5 MARKET STREET (SR 0230) & HIGH STREET (SR 0241/4008)	B-056	14(LEAD)	28		28	14(LEAD)	28		28	70	0
4 MARKET STREET (SR 0230) & WILLOW STREET	B-076		45		25		45		25	70	0
3 MARKET STREET (SR 0230) & LINDEN AVENUE (SR 0743/0241)	B-049		36	32	1		36	1		70	0
2 HERSHEY ROAD (SR 0743/0241), MOUNT GREINA ROAD (SR 0241), HOLLY STREET & TURKEY HILL DRIVEWAY	T-132									FREE	
1 HERSHEY ROAD (SR 0743) & PA 283 WB RAMP 0 (SR 8015)										FREE	
PROGRAM 4 = PA283 EB INCIDENT MANAGEMENT		PHASE 0000								CYCLE	OFFSET
INTERSECTIONS	FILE #	1	2	3	4	5	6	7	8		00
11 SOUTH MARKET STREET (SR 0230) & SHEAFFER ROAD	T-175		110		30		110		30	140	0
10 MARKET STREET (SR 0230) & MARKET STREET SQUARE DRIVEWAY	T-112	15 (LEAD)	110		15		125		15	140	129
9 MARKET STREET (SR 0230) & CAREY LANE/COMMERCIAL DRIVEWAY	T-173	12 (LEAD)	110		18		122		18	140	106
8 MARKET STREET (SR 0230) & MAYTOWN AVENUE (SR 0743)	B-054	12 (LEAD)	110	18			122			140	65
7 MARKET STREET (SR 0230) & ARCH STREET	B-077		110		30		110			140	35
17 MARKET STREET (SR 0230) & COLLEGE AVENUE	B-093	15 (LEAD)	110		15	15 (LEAD)	110		15	140	17
6 MARKET STREET (SR 0230) & BAINBRIDGE STREET	B-053		110		30		110			140	5
5 MARKET STREET (SR 0230) & HIGH STREET (SR 0241/4008)	B-056	15 (LEAD)	110		15	15 (LEAD)	110		15	140	106
4 MARKET STREET (SR 0230) & WILLOW STREET	B-076		110		30		110		30	140	74
3 MARKET STREET (SR 0230) & LINDEN AVENUE (SR 0743/0241)	B-049		28	110	1		28	1		140	79
2 HERSHEY ROAD (SR 0743/0241), MOUNT GREINA ROAD (SR 0241), HOLLY STREET & TURKEY HILL DRIVEWAY	T-132	50 (LEAD)	60	15	15		110		15	140	124
1 HERSHEY ROAD (SR 0743) & PA 283 WB RAMP 0 (SR 8015)										FREE	
PROGRAM 5 = PA283 WB INCIDENT MANAGEMENT		PHASE 0000								CYCLE	OFFSET
INTERSECTIONS	FILE #	1	2	3	4	5	6	7	8		00
11 SOUTH MARKET STREET (SR 0230) & SHEAFFER ROAD	T-175		110		30		110		30	140	0
10 MARKET STREET (SR 0230) & MARKET STREET SQUARE DRIVEWAY	T-112	15 (LEAD)	110		15		125		15	140	11
9 MARKET STREET (SR 0230) & CAREY LANE/COMMERCIAL DRIVEWAY	T-173	15 (LEAD)	95		30		110		30	140	34
8 MARKET STREET (SR 0230) & MAYTOWN AVENUE (SR 0743)	B-054	15 (LEAD)	95	30			110			140	75
7 MARKET STREET (SR 0230) & ARCH STREET	B-077		110		30		110			140	105
17 MARKET STREET (SR 0230) & COLLEGE AVENUE	B-093	15 (LEAD)	110		15	15 (LEAD)	110		15	140	133
6 MARKET STREET (SR 0230) & BAINBRIDGE STREET	B-053		110		30		110			140	35
5 MARKET STREET (SR 0230) & HIGH STREET (SR 0241/4008)	B-056	15 (LEAD)	110		15	15 (LEAD)	110		15	140	34
4 MARKET STREET (SR 0230) & WILLOW STREET	B-076		110		30		110		30	140	66
3 MARKET STREET (SR 0230) & LINDEN AVENUE (SR 0743/0241)	B-049		68	70	1		68	1		140	91
2 HERSHEY ROAD (SR 0743/0241), MOUNT GREINA ROAD (SR 0241), HOLLY STREET & TURKEY HILL DRIVEWAY	T-132	15 (LEAD)	95	15	15		110		15	140	16
1 HERSHEY ROAD (SR 0743) & PA 283 WB RAMP 0 (SR 8015)			125				70		55	140	96

**Notes:**  
 ① ALL SPLIT TIMES INCLUDE YELLOW AND RED TIMES FOR A GIVEN PHASE.  
 ② REFER TO SIGNAL PERMIT PLAN FOR MAX 1, MAX 2 AND CLEARANCE AND PED TIMES.  
 ③ SPLIT TIMES AND OFFSETS ARE IN SECONDS.  
 ④ OFFSETS REFERENCED TO BEGINNING OF MAIN STREET YELLOW (2+6).  
 ⑤ PHASES 4 AND 7 AT INTERSECTION #3 SERVE RESIDENTIAL DRIVEWAYS OPPOSITE THE INTERSECTION. CALLS TO PHASES 4 AND 7 TEMPORARILY SUSPEND COORDINATED OPERATION AT INTERSECTION 3.

**INTERSECTIONS 1-2**

WEEKLY PROGRAM CHART				
EVENT	DAY	TIME	PROGRAM*	REMARKS
1	1-7	0000	MAXIMUM 1	FREE

\* DAY 1 = MONDAY  
 \* MAX / FREE WHERE NOTED IN CYCLE / SPLIT / OFFSET MATRIX.

**INTERSECTIONS 3-11 AND 17**

WEEKLY PROGRAM CHART				
EVENT	DAY	TIME	PROGRAM*	REMARKS
1	1-7	0000	MAXIMUM 1	FREE
2	1-5	0600	1	AM PEAK
3	1-5	0900	2	PM PEAK
4	1-5	1930	MAXIMUM 1	FREE
5	6	0900	3	WEEKEND PEAK
6	6	1900	MAXIMUM 1	FREE
7	7	1100	3	WEEKEND PEAK
8	7	1500	MAXIMUM 1	FREE

\* DAY 1 = MONDAY  
 \* MAX / FREE WHERE NOTED IN CYCLE / SPLIT / OFFSET MATRIX.

GENERAL NOTES

NO MODIFICATIONS OF THIS INSTALLATION ARE PERMITTED UNLESS PRIOR APPROVAL IS GRANTED IN WRITING BY A REPRESENTATIVE OF THE DEPARTMENT OF TRANSPORTATION.

REFER TO TRAFFIC SIGNAL PERMIT DRAWING FOR INDIVIDUAL INTERSECTION OPERATION, GEOMETRY, PHASING AND CRITICAL TIMES.

FOR CONSTRUCTION AND INSPECTION THE SYSTEM PERMIT SHOULD ALWAYS BE ACCOMPANIED WITH TRAFFIC SIGNAL PERMIT DRAWING.

TEST THE SYSTEM AT LOCAL INTERSECTION LEVEL, SUBSYSTEM LEVEL MASTER CONTROLLER LEVEL AND PERSONAL COMPUTER REMOTE DIAL UP LEVEL.

GATHER THE SYSTEM FAILURE CRITICAL ALARMS REPORT AND ARCHIVE THEM WHERE APPLICABLE.

ASSIGN LOOP DETECTORS AND PROGRAM THE CONTROLLERS TO GATHER TRAFFIC VOLUMES IN 15 MINUTE INTERVAL, WHERE APPLICABLE.

EXACT LOCATION OF DETECTORS SHALL BE DETERMINED PRIOR TO INSTALLATION BY A REPRESENTATIVE OF PENNDOT.

OBTAIN POLE ATTACHMENT PERMIT FOR AERIAL FIBER OPTIC INSTALLATION.

MAINTAIN MASTER CONTROLLER COMMUNICATION SUCH AS PHONE DROPS.

PRIOR TO INSTALLATION THE CONTRACTOR SHALL CONSULT WITH THE LOCAL OFFICIALS AND UTILITY COMPANIES TO RESOLVE ANY PROBLEMS WHICH MAY BE CREATED DUE TO THE LOCATION OF UTILITIES.

CONDUIT INSTALLED IN BITUMINOUS ROADWAY LESS THAN 5 YEARS OLD, OR CONCRETE ROADWAY REGARDLESS OF AGE, MUST BE BORED OR JACKED UNDER THE ROADWAY. INSTALL IN ACCORDANCE WITH TRAFFIC SIGNAL STANDARDS TC-7800 SERIES.

THIS DRAWING CANNOT BE USED AS A CONSTRUCTION DRAWING UNLESS THE PERMITTEE COMPLIES WITH THE PROVISIONS OF THE LATEST AMENDMENT TO ACT 287, PREVENTION OF DAMAGE TO UNDERGROUND UTILITIES, DATED DECEMBER 20, 1974.

PERMITTEE SHALL OBTAIN A HIGHWAY OCCUPANCY PERMIT FOR ANY CHANGES IN INTERSECTION GEOMETRY REGARDING EXCAVATION.

TRAFFIC SIGNALS INSTALLED USING LIQUID FUELS TAX FUNDS MUST CONFORM TO DEPARTMENT SPECIFICATIONS AS SET FORTH IN CURRENT PUBLICATION 408, SUPPLEMENTS AND STANDARD DRAWINGS.

COUNTY: LANCASTER  
 MUNICIPALITY: ELIZABETHTOWN BOROUGH  
 MOUNT JOY TOWNSHIP  
 WEST DONEGAL TOWNSHIP  
 INTERSECTION: MARKET STREET (SR 0230)  
 CORRIDOR

REVIEWED:

*Rachel L. Home* 2/21/12  
 MUNICIPAL OFFICIAL DATE

*Joseph A. Pae* PE/PROE 02/15/2012  
 MUNICIPAL OFFICIAL DATE

*R. Ryan* 2/21/12  
 MUNICIPAL OFFICIAL DATE

RECOMMENDED:  
*Joan S. Beasley* 03/01/2012  
 DIST TRAFFIC ENGR DATE

MOVEMENT, PHASING, AND SEQUENCE CHART

PHASE	1+6			2+6				3				PRE-EMP 6			PRE-EMP 2			PRE-EMP 3			EMERGENCY FLASH		
	1	2	3	1	2	3	4	1	2	3	4	1	2	3	1	2	3	1	2	3			
INTERVAL SIGNAL	G	G	G	G	G	Y	R	R	R	R	R	R	R	R	R	R	R	R	R	R	Y		
1	G	Y	G	G	G	Y	R	R	R	R	R	R	R	R	R	R	R	R	R	R	Y		
2	G	G	G	G	G	Y	R	R	R	R	R	R	R	R	R	R	R	R	R	R	Y		
3,4	R	R	R	G	G	Y	R	R	R	R	R	R	R	R	R	R	R	R	R	R	Y		
5,6	R	R	R	R	R	R	R	G	G	Y	R	R	R	R	R	R	R	G	Y	R	R		
*7,8	H	H	H	M	FH	H	H	H	H	H	H	H	H	H	H	H	H	H	H	H	OFF		
*9,10,11,12	H	H	H	H	H	H	H	M	FH	H	H	H	H	H	H	H	H	H	H	H	OFF		
FAIL-SAFE A	OFF	OFF	OFF	OFF	OFF	OFF	OFF	OFF	OFF	OFF	OFF	OFF	OFF	OFF	OFF	OFF	OFF	OFF	OFF	OFF	OFF		
FAIL-SAFE B	OFF	OFF	OFF	OFF	OFF	OFF	OFF	OFF	OFF	OFF	OFF	OFF	OFF	OFF	OFF	OFF	OFF	OFF	OFF	OFF	OFF		
FAIL-SAFE C	OFF	OFF	OFF	OFF	OFF	OFF	OFF	OFF	OFF	OFF	OFF	OFF	OFF	OFF	OFF	OFF	OFF	OFF	OFF	OFF	OFF		
FIXED		3.0	2.0			4.2	2.0			3.8	2.6	**▲	4.2	2.0	**▲	4.2	2.0	**▲	4.2	2.0	**▲	3.8	2.6
MINIMUM	5			15				5															
ADDED INIT.	-			2.0				-															
MAX. INITIAL	-			25				-															
PASSAGE	3			6				3															
TBR	-			20				-															
TTR	-			10				-															
MIN. GAP	-			3.5				-															
MAXIMUM	15			45				25															
PEDESTRIAN	-			8	7			7	9														
MEMORY	NON-LOCK			MIN-RECALL				NON-LOCK															

SIGNALIZATION NOTES

- \* UPON PEDESTRIAN ACTUATION, OTHERWISE DONT WALK AT ALL TIMES
- 1. PHASE 2+6 ON OMTS PHASE 1.
- 2. REMAINS G IF FOLLOWED BY PHASE 2+6.
- ▲ DURATION OF PRE-EMPTION
- \*\* SELECTIVE CLEARANCE INTERVAL INCLUDES THE NORMAL ALL RED TIMINGS

EMERGENCY PRE-EMPTION NOTES:

OPERATION: CONTROLLER TO BE EQUIPPED WITH EMERGENCY PRE-EMPTION FOR THE ALL APPROACHES WHICH WILL TERMINATE THE GREEN INTERVALS AND PROVIDE A SELECTIVE CLEARANCE (YELLOW & ALL RED) WHEN ACTIVATED BY EMERGENCY TRANSMISSION.

CLEARANCE: IF PRE-EMPTION OCCURS DURING A PHASE CLEARANCE INTERVAL, THAT INTERVAL WILL CONTINUE TO TIME OUT FOLLOWED BY PRE-EMPTED PHASE.

GREEN PHASE: IF PRE-EMPTION OCCURS DURING GREEN PHASE THE CONTROLLER WILL REMAIN IN THAT PHASE FOR DURATION OF PRE-EMPTION.

FLASHING: IF PRE-EMPTION OCCURS DURING FLASHING OPERATION SIGNALS REMAIN IN FLASH.

PEDESTRIAN: IF PRE-EMPTION OCCURS DURING PEDESTRIAN PHASE, THE WALK/MAN INDICATIONS WILL TERMINATE IMMEDIATELY FOLLOWED BY THE PEDESTRIAN CLEARANCE PHASE. IF PREEMPTION OCCURS DURING THE PEDESTRIAN CLEARANCE PHASE "FLASHING HAND" CONTINUES IN ITS ENTIRETY THAN THE PREEMPTIVE PHASE.

PRIORITY: IN EMERGENCY PRE-EMPTION, NO PRIORITY SHALL BE ESTABLISHED, PRE-EMPTION SHALL BE A "FIRST COME, FIRST SERVE" OPERATION.

RETURN: UPON COMPLETION OF PRE-EMPTION, OPERATION RESUMES IN PHASE 2+6

FAIL SAFE: FAIL SAFE LIGHT WILL CONSIST OF A WHITE LIGHT FOR EACH APPROACH WHICH WILL FLASH WHEN EMERGENCY TRANSMISSION HAS CONTROL OF PRE-EMPTED APPROACH.

EQUIPMENT LOCATION: LOCATION OF EMERGENCY VEHICLE DETECTORS ARE TO BE FIELD ADJUSTED TO ACHIEVE MAXIMUM OPERATION.

ENCODING: IF THE PRE-EMPTION EQUIPMENT HAS ENCODING CAPABILITIES FOR VEHICLE IDENTIFICATION, IT IS RECOMMENDED TO HAVE THE ZERO "00" POSITION ON TO GIVE UNCODED EMITTERS THE ABILITY TO ACTIVATE THE EMERGENCY PREEMPTION.

PERMIT NUMBER: 003370 SHEET 2 OF 2  
 DATE ISSUED: 02-21-92 DATE REVISED: 6-12-19

GENERAL NOTES

INSTALLATION, OPERATION, AND MAINTENANCE OF THIS TRAFFIC SIGNAL TO BE IN ACCORDANCE WITH PENNSYLVANIA DEPARTMENT OF TRANSPORTATION REGULATIONS ON OFFICIAL TRAFFIC CONTROL DEVICES.

THE BOTTOM OF SIGNAL HEADS AND SIGNS ERRECTED OVER THE ROADWAY ARE NOT TO BE LESS THAN 15 FEET NOR MORE THAN 19 FEET ABOVE THE ROADWAY. THE BOTTOM OF POST MOUNTED SIGNAL HEADS ARE NOT TO BE LESS THAN 8 FEET NOR MORE THAN 15 FEET ABOVE THE SIDEWALK OR PAVEMENT GRADE.

NO MODIFICATIONS OF THIS INSTALLATION ARE PERMITTED UNLESS PRIOR APPROVAL IS GRANTED, IN WRITING, BY THE DEPARTMENT.

ALL MAINTENANCE NECESSARY FOR PROPER VISIBILITY OF THE SIGNALS, INCLUDING TRIMMING TREES, IS THE RESPONSIBILITY OF THE PERMITTEE.

ALL SIGNS AND PAVEMENT MARKINGS INDICATED ON THIS DRAWING ARE CONSIDERED PART OF THE PERMIT AND ARE TO BE INSTALLED AND MAINTAINED BY THE PERMITTEE, UNLESS OTHERWISE INDICATED. EXCEPT THE LONGITUDINAL PAVEMENT MARKINGS ON STATE HIGHWAYS WHICH WILL BE MAINTAINED BY THE DEPARTMENT.

INSTALL POST MOUNTED SIGNALS WITH THE SIGNAL HEADS A MINIMUM OF 2 FEET BEHIND THE FACE OF THE CURB OR EDGE OF THE SHOULDER. SUPPORT POLES FOR OVERHEAD SIGNALS WILL HAVE A MINIMUM HORIZONTAL CLEARANCE OF 2 FEET.

PERMITTEE SHALL OBTAIN A HIGHWAY OCCUPANCY PERMIT FOR EMBANKMENT REMOVAL, CURBING AND/OR SIDEWALK, DRAINAGE STRUCTURES, CHANGES IN HIGHWAY GEOMETRY, PAVEMENT WIDENING, OR INSTALLATION OF ADDITIONAL LANES.

CONDUIT INSTALLED IN BITUMINOUS ROADWAY LESS THAN 5 YEARS OLD, OR CONCRETE ROADWAY REGARDLESS OF AGE, MUST BE BORED OR JACKED UNDER THE ROADWAY. INSTALL IN ACCORDANCE WITH TRAFFIC SIGNAL STANDARDS TC-8800 SERIES.

THIS DRAWING CANNOT BE USED AS A CONSTRUCTION DRAWING UNLESS THE PERMITTEE COMPLIES WITH THE PROVISIONS OF ACT 50, UNDERGROUND UTILITY LINE PROTECTION ACT DATED APRIL 28, 2018. PRIOR TO CONSTRUCTION, CONSULT WITH UTILITY COMPANIES TO RESOLVE ANY PROBLEMS WHICH MAY BE CREATED DUE TO THE LOCATION OF UTILITIES.

PAVEMENT MARKINGS WILL BE PLACED IN ACCORDANCE WITH THE DEPARTMENT OF TRANSPORTATION PAVEMENT MARKING HANDBOOK.

PERMITTEE IS RESPONSIBLE FOR OBTAINING APPROVAL FOR INSTALLATION OF TRAFFIC SIGNAL DEVICES LOCATED OUTSIDE HIGHWAY RIGHT-OF-WAY.

TRAFFIC SIGNALS INSTALLED USING LIQUID FUELS TAX FUND MUST CONFORM TO DEPARTMENT SPECIFICATIONS AS SET FORTH IN CURRENT PUBLICATION 408, SUPPLEMENTS AND STANDARD DRAWINGS.

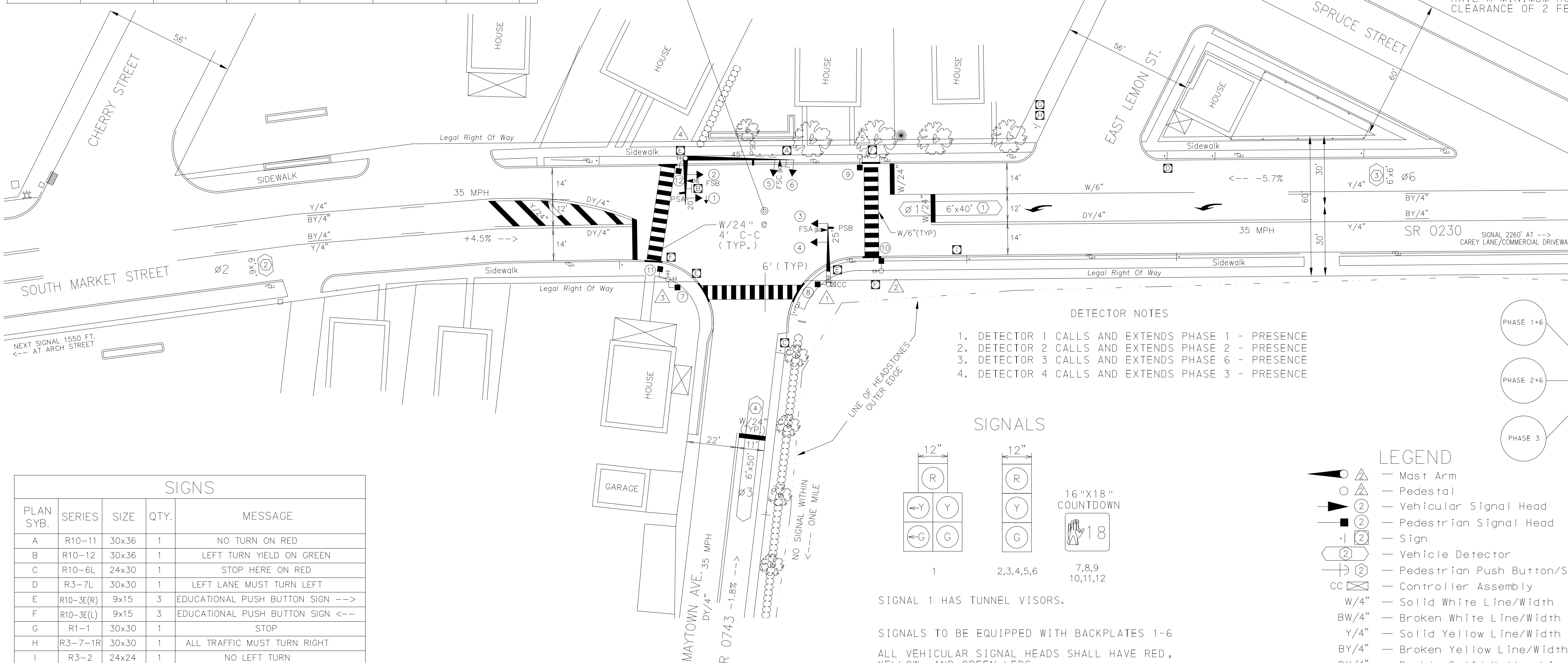

DETECTOR NOTES

1. DETECTOR 1 CALLS AND EXTENDS PHASE 1 - PRESENCE
2. DETECTOR 2 CALLS AND EXTENDS PHASE 2 - PRESENCE
3. DETECTOR 3 CALLS AND EXTENDS PHASE 6 - PRESENCE
4. DETECTOR 4 CALLS AND EXTENDS PHASE 3 - PRESENCE

SIGNALS

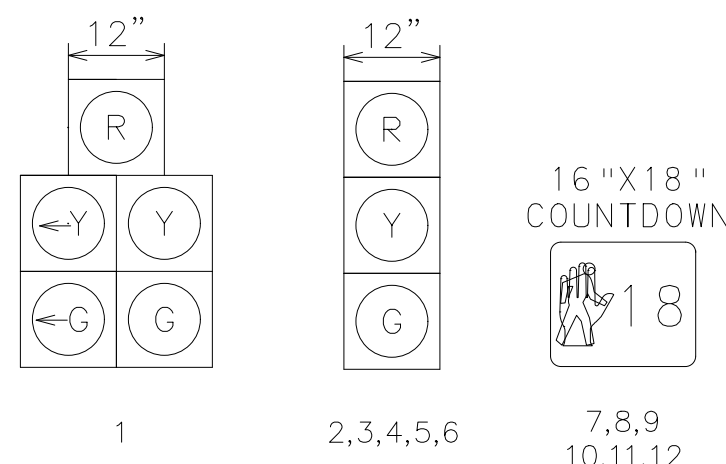

SIGNAL 1 HAS TUNNEL VISORS.

SIGNALS TO BE EQUIPPED WITH BACKPLATES 1-6

ALL VEHICULAR SIGNAL HEADS SHALL HAVE RED, YELLOW, AND GREEN LEDS.

ALL PEDESTRIAN SIGNAL HEADS SHALL HAVE LUNAR WHITE AND PORTLAND ORANGE LEDS.

LEGEND

- Mast Arm
- Pedestal
- Vehicular Signal Head
- Pedestrian Signal Head
- Sign
- Vehicle Detector
- Pedestrian Push Button/Sign
- Controller Assembly
- W/4" - Solid White Line/Width
- BW/4" - Broken White Line/Width
- Y/4" - Solid Yellow Line/Width
- BY/4" - Broken Yellow Line/Width
- DY/4" - Double Solid Yellow Line/Width
- FSA - Preemption Fail-Safe Light/Identification
- PSA - Preemption Sensor/Identification

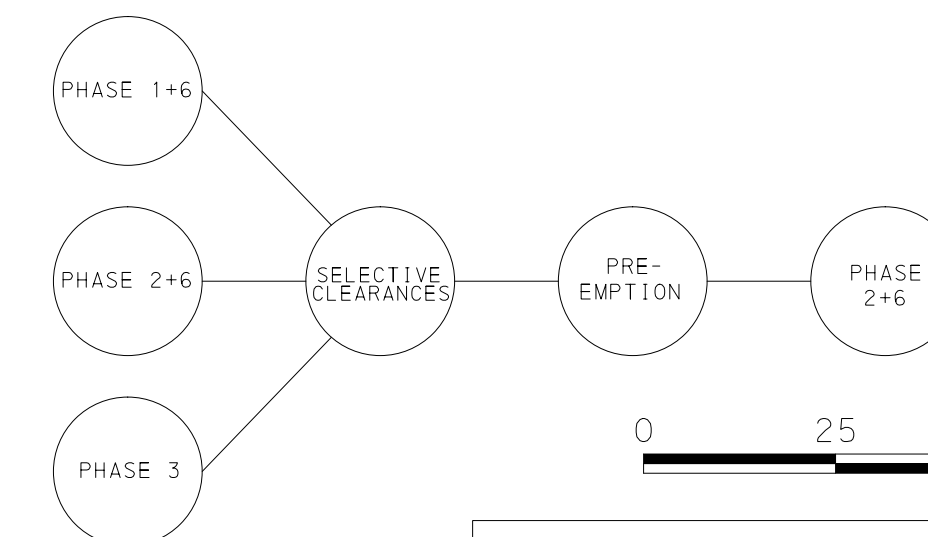

0 25 50 FEET

SIGNS				
PLAN SYB.	SERIES	SIZE	QTY.	MESSAGE
A	R10-11	30x36	1	NO TURN ON RED
B	R10-12	30x36	1	LEFT TURN YIELD ON GREEN
C	R10-6L	24x30	1	STOP HERE ON RED
D	R3-7L	30x30	1	LEFT LANE MUST TURN LEFT
E	R10-3E(R)	9x15	3	EDUCATIONAL PUSH BUTTON SIGN -->
F	R10-3E(L)	9x15	3	EDUCATIONAL PUSH BUTTON SIGN <--
G	R1-1	30x30	1	STOP
H	R3-7-1R	30x30	1	ALL TRAFFIC MUST TURN RIGHT
I	R3-2	24x24	1	NO LEFT TURN

COUNTY: LANCASTER  
 MUNICIPALITY: ELIZABETHTOWN BOROUGH  
 INTERSECTION: MARKET STREET (SR 0230) AND MAYTOWN AVENUE (SR 0743)

REVIEWED: R. Ryan 5-17-19  
 MUNICIPAL OFFICIAL DATE

RECOMMENDED: \_\_\_\_\_  
 DIST TRAFFIC ENGR DATE





T-175

GENERAL NOTES

INSTALLATION, OPERATION AND MAINTENANCE OF THIS TRAFFIC SIGNAL SHALL BE IN ACCORDANCE WITH PENNSYLVANIA DEPARTMENT OF TRANSPORTATION REGULATIONS ON OFFICIAL TRAFFIC CONTROL DEVICES.

NO MODIFICATION OF THIS INSTALLATION IS PERMITTED UNLESS PRIOR APPROVAL IS GRANTED, IN WRITING, BY THE DEPARTMENT.

ALL MAINTENANCE NECESSARY FOR PROPER VISIBILITY OF THE SIGNAL, INCLUDING TRIMMING TREES, IS THE RESPONSIBILITY OF THE PERMITTEE.

ALL SIGNS AND PAVEMENT MARKINGS INDICATED ON THIS DRAWING ARE CONSIDERED PART OF THE PERMIT AND SHALL BE INSTALLED AND MAINTAINED BY THE PERMITTEE, UNLESS OTHERWISE INDICATED. EXCEPT THE LONGITUDINAL PAVEMENT MARKINGS ON STATE HIGHWAYS, WHICH WILL BE MAINTAINED BY THE DEPARTMENT.

POST MOUNTED SIGNALS SHALL BE INSTALLED WITH THE SIGNAL HEADS A MINIMUM OF 2 FEET BEHIND THE FACE OF THE CURB OR EDGE OF THE SHOULDER. SUPPORT POLES FOR OVERHEAD SIGNALS SHALL ALSO HAVE A MINIMUM HORIZONTAL CLEARANCE OF 2 FEET.

THE BOTTOM OF SIGNAL HEADS AND SIGNS ERECTED OVER THE ROADWAY SHALL NOT BE LESS THAN 15 FEET OR MORE THAN 19 FEET ABOVE THE ROADWAY. THE BOTTOM OF POST MOUNTED SIGNAL HEADS SHALL NOT BE LESS THAN 8 FEET NOR MORE THAN 15 FEET ABOVE THE SIDEWALK OR PAVEMENT GRADE.

THE MINIMUM HORIZONTAL DISTANCE BETWEEN SIGNAL HEADS, MEASURED AT RIGHT ANGLES TO THE APPROACH, SHALL BE 8 FEET.

PERMITTEE SHALL OBTAIN A HIGHWAY OCCUPANCY PERMIT FOR EMBANKMENT REMOVAL, CURBING, AND/OR SIDEWALK AND DRAINAGE STRUCTURES, CHANGES IN HIGHWAY GEOMETRY, PAVEMENT WIDENING, OR INSTALLATION OF ADDITIONAL LANES.

CONDUIT INSTALLED IN BITUMINOUS ROADWAY LESS THAN 5 YEARS OLD, OR CONCRETE ROADWAY REGARDLESS OF AGE, MUST BE BORED OR JACKED UNDER THE ROADWAY. INSTALL IN ACCORDANCE WITH TRAFFIC SIGNAL STANDARDS TC-7800 SERIES.

THIS DRAWING CANNOT BE USED AS A CONSTRUCTION DRAWING UNLESS THE PERMITTEE COMPLIES WITH THE PROVISIONS OF ACT 237, PREVENTION OF DAMAGE TO UNDERGROUND UTILITIES. PRIOR TO CONSTRUCTION, CONSULT WITH UTILITY COMPANIES TO RESOLVE ANY PROBLEMS WHICH MAY BE CREATED DUE TO THE LOCATION OF UTILITIES.

PAVEMENT MARKINGS SHALL BE PLACED IN ACCORDANCE WITH THE DEPARTMENT OF TRANSPORTATION PAVEMENT MARKING HANDBOOK.

PERMITTEE IS RESPONSIBLE FOR OBTAINING APPROVAL FOR INSTALLATION OF TRAFFIC SIGNAL DEVICES LOCATED OUTSIDE HIGHWAY RIGHT-OF-WAY.

TRAFFIC SIGNALS INSTALLED USING LIQUID TAX FUNDS MUST CONFORM TO DEPARTMENT SPECIFICATIONS AS SET FORTH IN CURRENT PUBLICATION 408, SUPPLEMENTS AND STANDARD DRAWINGS.

NOTE: SHEAFFER ROAD FORMERLY KNOWN AS SCHWANGER ROAD.



COUNTY: LANCASTER  
 MUNICIPALITY: MOUNT JOY TOWNSHIP  
 INTERSECTION: S. MARKET ST. (SR 0230) AND SHEAFFER ROAD

REVIEWED: *Joseph A. Coy, P.E., PTOE* 05-03-2011  
 MUNICIPAL OFFICIAL DATE  
 RECOMMENDED: *John C. Bewley* 05/11/2011  
 DIST TRAFFIC ENGR DATE

MOVEMENT, SEQUENCE AND TIMING

	2 + 6				4 + 8				
PHASE	1	2	3	4	1	2	3	4	
SIGNAL	1,2,3,4	G	G	Y	R	R	R	R	Y
	5,6,7,8	R	R	R	R	G	Y	R	R
	9,12,13,15	H	H	H	H	M	FH	H	H
	10,11,14,16	M	FH	H	H	H	H	H	OFF
FIXED			4.3	1.6					
MINIMUM	15				3.0				
ADDED INT	3.0								
MAX INT	30								
PASSAGE	6.0				3.0				
TBR	30								
TTR	15								
MIN GAP	3.5								
MAX I	45				20				
MAX II									
PED*	11   13				14   17				OFF
MEMORY	MIN RECALL				NON-LOCKING				

\* UPON PEDESTRIAN ACTUATION ONLY

FOR COORDINATED TIMINGS, REFER TO SYSTEM PERMIT I-0002.

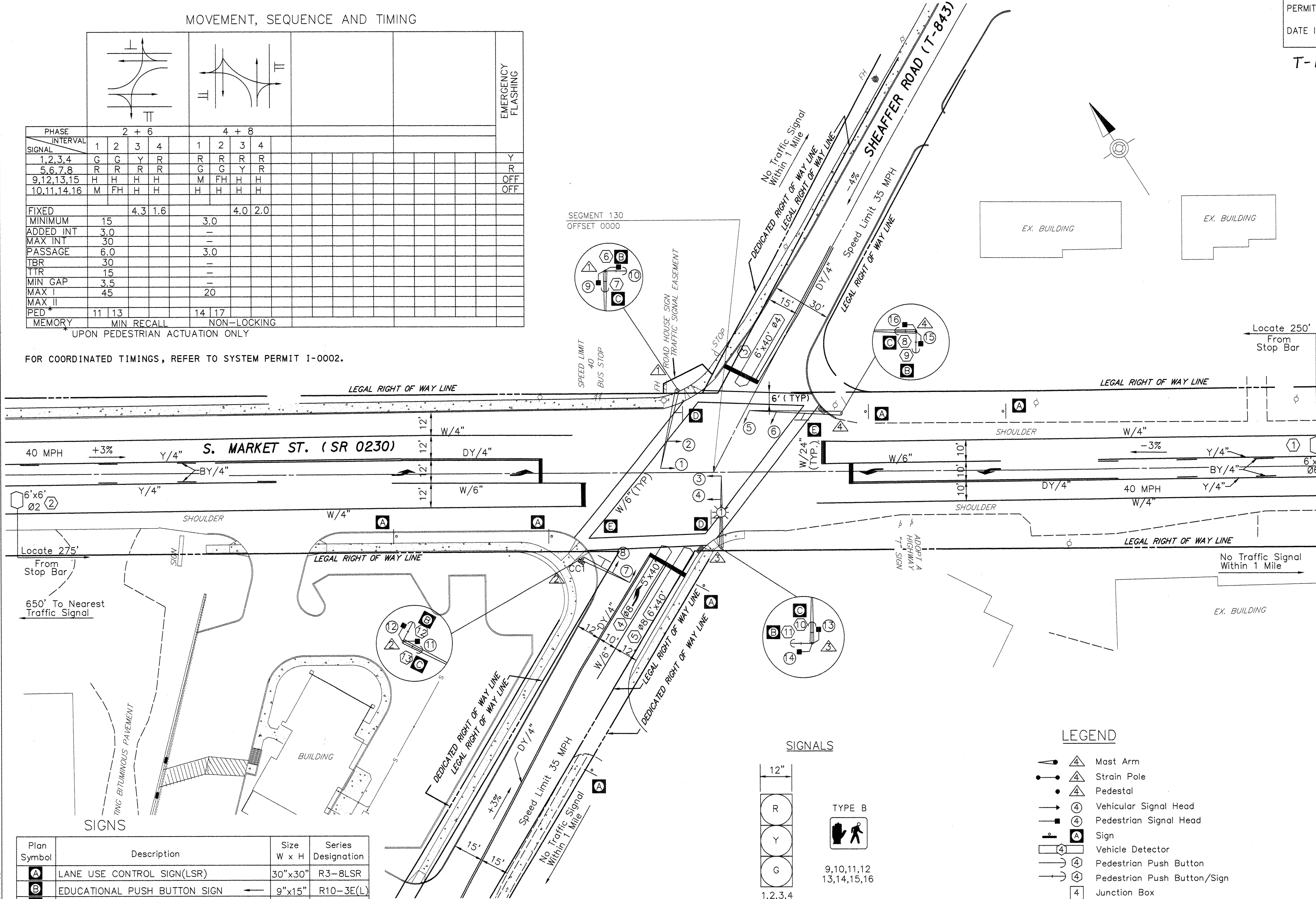

Plan Symbol	Description	Size W x H	Series Designation
A	LANE USE CONTROL SIGN(LSR)	30"x30"	R3-8LSR
B	EDUCATIONAL PUSH BUTTON SIGN	9"x15"	R10-3E(L)
C	EDUCATIONAL PUSH BUTTON SIGN	9"x15"	R10-3E(R)
D	STREET NAME: "Sheaffer Rd"	*	D3-4
E	STREET NAME: "Market St"	*	D3-4

\* SIZE AS REQUIRED

DETECTOR NOTES

- DETECTOR 1 CALLS AND EXTENDS PHASE 6 - PRESENCE
- DETECTOR 2 CALLS AND EXTENDS PHASE 2 - PRESENCE
- DETECTOR 3 CALLS AND EXTENDS PHASE 4 - PRESENCE
- DETECTORS 4 AND 5 CALL AND EXTEND PHASE 8 - PRESENCE

SIGNALS

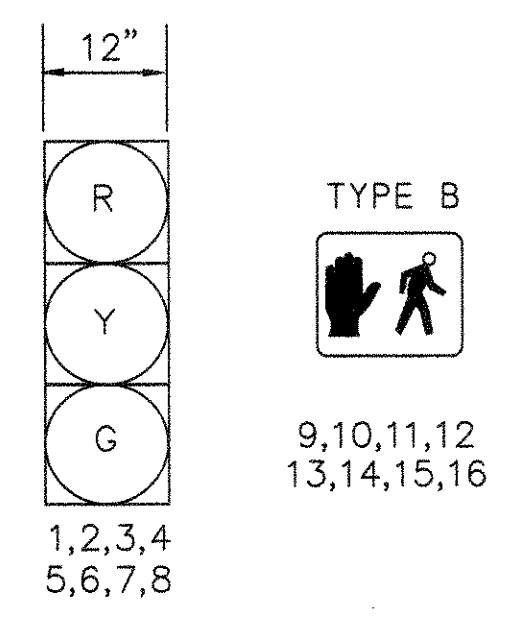

SIGNALS 1 - 8 TO BE EQUIPPED WITH BACKPLATES.

ALL VEHICULAR SIGNAL HEADS SHALL HAVE RED, YELLOW, AND GREEN LEDS.

ALL PEDESTRIAN SIGNAL HEADS SHALL HAVE LUNAR WHITE AND PORTLAND ORANGE LEDS.

LEGEND

- ▲ Mast Arm
- Strain Pole
- Pedestal
- ④ Vehicular Signal Head
- ④ Pedestrian Signal Head
- ④ Sign
- ④ Vehicle Detector
- ④ Pedestrian Push Button
- ④ Pedestrian Push Button/Sign
- ④ Junction Box
- C/2" Conduit/Size
- CC4 Controller Assembly
- W/4" Solid White Line/Width
- BW/4" Broken White Line/Width
- Y/4" Solid Yellow Line/Width
- BY/4" Broken Yellow Line/Width
- DY/4" Double Solid Yellow Line/Width
- ☼ Luminaire

GENERAL NOTES

NO MODIFICATIONS OF THIS INSTALLATION ARE PERMITTED UNLESS PRIOR APPROVAL IS GRANTED IN WRITING BY A REPRESENTATIVE OF THE DEPARTMENT OF TRANSPORTATION.

REFER TO TRAFFIC SIGNAL PERMIT DRAWING FOR INDIVIDUAL INTERSECTION OPERATION, GEOMETRY, PHASING AND CRITICAL TIMES.

FOR CONSTRUCTION AND INSPECTION THE SYSTEM PERMIT SHOULD ALWAYS BE ACCOMPANIED WITH TRAFFIC SIGNAL PERMIT DRAWING.

TEST THE SYSTEM AT LOCAL INTERSECTION LEVEL, SUBSYSTEM LEVEL MASTER CONTROLLER LEVEL AND PERSONAL COMPUTER REMOTE DIAL UP LEVEL.

GATHER THE SYSTEM FAILURE CRITICAL ALARMS REPORT AND ARCHIVE THEM WHERE APPLICABLE.

ASSIGN LOOP DETECTORS AND PROGRAM THE CONTROLLERS TO GATHER TRAFFIC VOLUMES IN 15 MINUTE INTERVAL, WHERE APPLICABLE.

EXACT LOCATION OF DETECTORS SHALL BE DETERMINED PRIOR TO INSTALLATION BY A REPRESENTATIVE OF PENNDOT.

OBTAIN POLE ATTACHMENT PERMIT FOR AERIAL FIBER OPTIC INSTALLATION.

MAINTAIN MASTER CONTROLLER COMMUNICATION SUCH AS PHONE DROPS.

PRIOR TO INSTALLATION THE CONTRACTOR SHALL CONSULT WITH THE LOCAL OFFICIALS AND UTILITY COMPANIES TO RESOLVE ANY PROBLEMS WHICH MAY BE CREATED DUE TO THE LOCATION OF UTILITIES.

CONDUIT INSTALLED IN BITUMINOUS ROADWAY LESS THAN 5 YEARS OLD, OR CONCRETE ROADWAY REGARDLESS OF AGE, MUST BE BORED OR JACKED UNDER THE ROADWAY. INSTALL IN ACCORDANCE WITH TRAFFIC SIGNAL STANDARDS TC-7800 SERIES.

THIS DRAWING CANNOT BE USED AS A CONSTRUCTION DRAWING UNLESS THE PERMITTEE COMPLIES WITH THE PROVISIONS OF THE LATEST AMENDMENT TO ACT 287, PREVENTION OF DAMAGE TO UNDERGROUND UTILITIES, DATED DECEMBER 20, 1974.

PERMITTEE SHALL OBTAIN A HIGHWAY OCCUPANCY PERMIT FOR ANY CHANGES IN INTERSECTION GEOMETRY REGARDING EXCAVATION.

TRAFFIC SIGNALS INSTALLED USING LIQUID FUELS TAX FUNDS MUST CONFORM TO DEPARTMENT SPECIFICATIONS AS SET FORTH IN CURRENT PUBLICATION 408, SUPPLEMENTS AND STANDARD DRAWINGS.

COUNTY: LANCASTER  
 MUNICIPALITY: MOUNT JOY TOWNSHIP

INTERSECTION: CLOVERLEAF ROAD (SR 4025)  
 CORRIDOR

REVIEWED: *Sheila A. Carr* 8/1/2011  
 MUNICIPAL OFFICIAL DATE

RECOMMENDED: *Deann C. Bewley* 08/25/2011  
 DIST TRAFFIC ENGR DATE

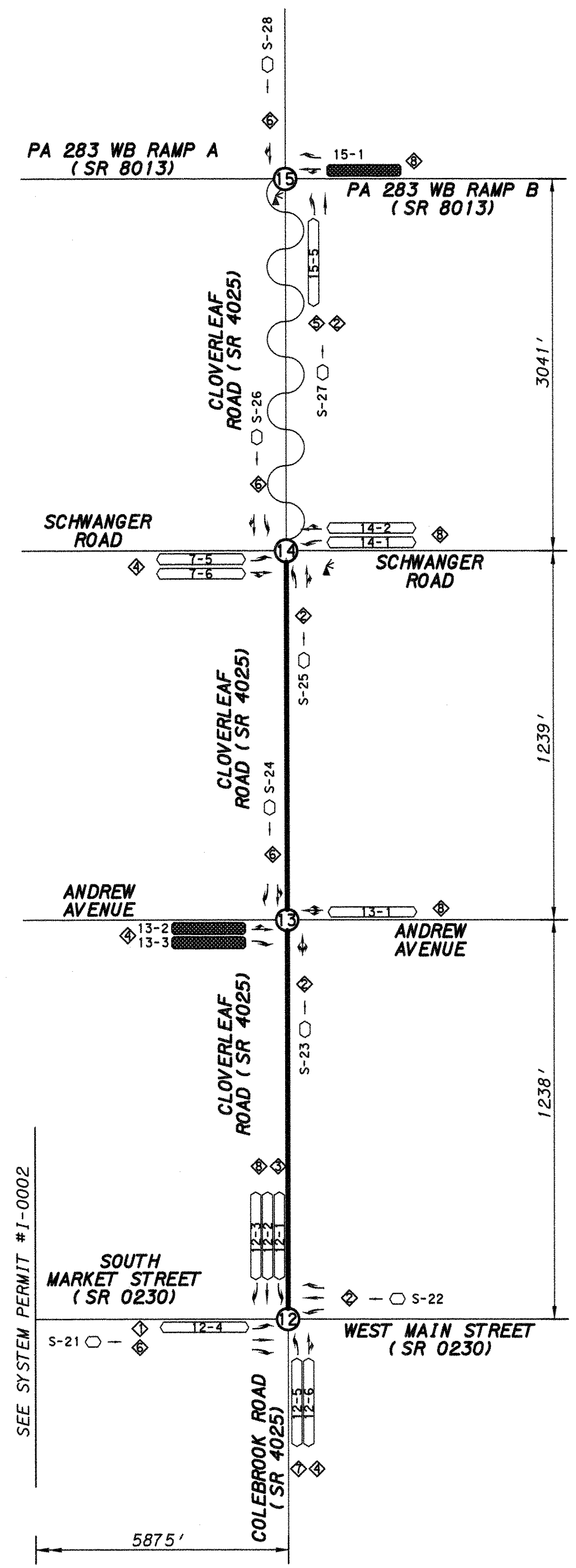

Notes:  
 MASTER CONTROLLER FOR LOCATED AT CLOVERLEAF ROAD AND SCHWANGER ROAD (INTERSECTION #14)  
 CENTRAL SYSTEM COMPUTER TO OPERATE USING ECONOLITE ARIES SOFTWARE.

INTERSECTIONS 12-14

EVENT	DAY	TIME	PROGRAM	REMARKS
1	1-7	0000	MAXIMUM 1	FREE
2	1-5	0600	1	AM PEAK
3	1-5	0900	MAXIMUM 1	FREE
4	1-5	1430	1	PM PEAK
5	1-5	1900	MAXIMUM 1	FREE
6	6	0900	3	WEEKEND PEAK
7	6	1700	MAXIMUM 1	FREE

\* DAY 1 = MONDAY  
 \* MAX / FREE WHERE NOTED IN CYCLE / SPLIT / OFFSET MATRIX.

INTERSECTION 15

EVENT	DAY	TIME	PROGRAM	REMARKS
1	1-7	0000	MAXIMUM 1	FREE

\* DAY 1 = MONDAY  
 \* MAX / FREE WHERE NOTED IN CYCLE / SPLIT / OFFSET MATRIX.

CYCLE / SPLIT / OFFSET

PROGRAM	INTERSECTIONS	FILE #	PHASE								CYCLE	OFFSET
			1	2	3	4	5	6	7	8		
PROGRAM 1 = AM PEAK	INTERSECTIONS											
15	CLOVERLEAF ROAD (SR 4025) & PA 283 WB RAMP B (SR 8013)	T-271									FREE	
14	CLOVERLEAF ROAD (SR 4025) & SCHWANGER ROAD	T-273		45		25			45		70	0
13	CLOVERLEAF ROAD (SR 4025) & ANDREW AVENUE	T-272		53		17			53		70	63
12	HARRISBURG PIKE (SR 0230), CLOVERLEAF ROAD (SR 4025) & COLEBROOK ROAD (SR 4025)	T-044									FREE	
PROGRAM 2 = PM PEAK	INTERSECTIONS											
15	CLOVERLEAF ROAD (SR 4025) & PA 283 WB RAMP B (SR 8013)	T-271									FREE	
14	CLOVERLEAF ROAD (SR 4025) & SCHWANGER ROAD	T-273		43		17			43		60	0
13	CLOVERLEAF ROAD (SR 4025) & ANDREW AVENUE	T-272		45		15			45		60	25
12	HARRISBURG PIKE (SR 0230), CLOVERLEAF ROAD (SR 4025) & COLEBROOK ROAD (SR 4025)	T-044	23(LEAD)	45	20(LEAD)	32			68	15(LEAD)	37	107
PROGRAM 3 = WEEKEND PEAK	INTERSECTIONS											
15	CLOVERLEAF ROAD (SR 4025) & PA 283 WB RAMP B (SR 8013)	T-271									FREE	
14	CLOVERLEAF ROAD (SR 4025) & SCHWANGER ROAD	T-273		40		20			40		60	0
13	CLOVERLEAF ROAD (SR 4025) & ANDREW AVENUE	T-272		44		16			44		60	33
12	HARRISBURG PIKE (SR 0230), CLOVERLEAF ROAD (SR 4025) & COLEBROOK ROAD (SR 4025)	T-044									FREE	
PROGRAM 4 = PA283 EB INCIDENT MANAGEMENT	INTERSECTIONS											
15	CLOVERLEAF ROAD (SR 4025) & PA 283 WB RAMP B (SR 8013)	T-271									FREE	
14	CLOVERLEAF ROAD (SR 4025) & SCHWANGER ROAD	T-273		110		30			110		30	140
13	CLOVERLEAF ROAD (SR 4025) & ANDREW AVENUE	T-272		110		30			110		30	119
12	HARRISBURG PIKE (SR 0230), CLOVERLEAF ROAD (SR 4025) & COLEBROOK ROAD (SR 4025)	T-044	98	14	14	14			112	14	14	98
PROGRAM 5 = PA283 WB INCIDENT MANAGEMENT	INTERSECTIONS											
15	CLOVERLEAF ROAD (SR 4025) & PA 283 WB RAMP B (SR 8013)	T-271		30				SKIP	30		110	140
14	CLOVERLEAF ROAD (SR 4025) & SCHWANGER ROAD	T-273		110		30			110		30	140
13	CLOVERLEAF ROAD (SR 4025) & ANDREW AVENUE	T-272		110		30			110		30	140
12	HARRISBURG PIKE (SR 0230), CLOVERLEAF ROAD (SR 4025) & COLEBROOK ROAD (SR 4025)	T-044	15	15	55	55			30		110	140

Notes:  
 - ALL SPLIT TIMES INCLUDE YELLOW AND RED TIMES FOR A GIVEN PHASE.  
 - REFER TO SIGNAL PERMIT PLAN FOR MAX 1, MAX 2 AND CLEARANCE AND PED TIMES.  
 - SPLIT TIMES AND OFFSETS ARE IN SECONDS.  
 - OFFSETS REFERENCED TO BEGINNING OF MAIN STREET YELLOW (2+6).

- LEGEND
- ④ INTERSECTION ADDRESS
  - Ⓜ SYSTEM LOOP/IDENTIFYING NUMBER
  - LOOP SENSOR / INTERSECTION X - LOOP NUMBER Y
  - ▬ VIDEO DETECTION AREA
  - ◆ PHASE NUMBER
  - ⚡ SPREAD SPECTRUM RADIO RECEIVER
  - FIBER OPTIC INTERCONNECTION
  - ~ RADIO CONNECTION
  - NOT TO SCALE



**MOVEMENT, SEQUENCE, AND TIMING DIAGRAM**

PHASE	1+6				2+6				3+7				3+8				4+7				4+8			
	1	2	3	4	1	2	3	4	1	2	3	4	1	2	3	4	1	2	3	4	1	2	3	4
SIGNAL INTERVAL	1	2	3	4	1	2	3	4	1	2	3	4	1	2	3	4	1	2	3	4	1	2	3	4
1	G	G	Y	R	G	G	Y	R	R	R	R	R	R	R	R	R	R	R	R	R	R	R	R	R
2	R	R	R	R	R	R	R	R	R	R	R	R	R	R	R	R	R	R	R	R	R	R	R	R
3, 4	R	R	R	R	G	G	Y	R	R	R	R	R	R	R	R	R	R	R	R	R	R	R	R	R
5, 9	R	R	R	R	R	R	R	R	R	R	R	R	R	R	R	R	R	R	R	R	R	R	R	R
6	R	R	R	R	R	R	R	R	R	R	R	R	R	R	R	R	R	R	R	R	R	R	R	R
7	R	R	R	R	R	R	R	R	R	R	R	R	R	R	R	R	R	R	R	R	R	R	R	R
8	R	R	R	R	R	R	R	R	R	R	R	R	R	R	R	R	R	R	R	R	R	R	R	R
10,11	H	H	H	H	H	H	H	H	H	H	H	H	H	H	H	H	H	H	H	H	H	H	H	H
12,13	M	FH	H	H	M	FH	H	H	H	H	H	H	H	H	H	H	H	H	H	H	H	H	H	H
FAIL-SAFE LAMP A																								
FAIL-SAFE LAMP B																								
FAIL-SAFE LAMP C																								
FAIL-SAFE LAMP D																								
FIXED		4.5	2			4.5	2			4	3			4	3			4	3			4	3	
MINIMUM	3				12				3				3				3				3			
PASSAGE	3				0.5				3				3				3				3			
MAXIMUM 1	17				55				15				30				15				30			
PEDESTRIAN	⑦				⑧				⑨				⑨				⑨				⑨			
MEMORY		NON-LOCKING			MIN. RECALL				NON-LOCKING				NON-LOCKING				NON-LOCKING				NON-LOCKING			

**OPERATION NOTES**

- ① G IF FOLLOWED BY 2+6
- ② G IF FOLLOWED BY 2+6
- ③ R IF FOLLOWED BY 3+8
- ④ R IF FOLLOWED BY 4+7
- ⑤ Y IF FOLLOWED BY 4+8
- ⑥ G IF FOLLOWED BY 4+8
- ⑦ UPON PEDESTRIAN ACTUATION ONLY
- ⑧ TIMING WILL BE AS SHOWN IN PHASE 2+6. IT MAY TIME OUT IN THIS PHASE OR BE COMPLETED IN PHASE 2+6.
- ⑨ TIMING WILL BE AS SHOWN IN PHASE 4+8. IT MAY TIME OUT IN THIS PHASE OR BE COMPLETED IN PHASE 4+8.

**ADVANCE DILEMMA ZONE NOTES (ZONE 1):**

ESTIMATED TIME OF ARRIVAL: MIN 2.5 - MAX 5.5 SEC.  
 RANGE OF DETECTION: MIN 50 - MAX 350 FT. FROM STOP BAR  
 MINIMUM SPEED BOUNDARY 25 MPH  
 ZONE MAY BE ADJUSTED IN FIELD.

**DETECTOR NOTES**

- DETECTION ZONE 1 CALLS AND EXTENDS PHASE 1 - PRESENCE
- DETECTION ZONE 3 CALLS AND EXTENDS PHASE 3 - PRESENCE
- DETECTION ZONE 4 CALLS AND EXTENDS PHASE 4 - PRESENCE
- DETECTION ZONE 7 CALLS AND EXTENDS PHASE 7 - PRESENCE
- DETECTION ZONES 8a & 8b CALL AND EXTEND PHASE 8 - PRESENCE
- DETECTORS 10,11 CALL PEDESTRIAN SIGNALS FOR PHASE 4+8 - PUSH BUTTON
- DETECTORS 12,13 CALL PEDESTRIAN SIGNALS FOR PHASE 2+6 - PUSH BUTTON

**DENSITY ZONE NOTES (ZONE 2):**

RANGE OF DETECTION: MIN 30 - MAX 50 FT. FROM STOP BAR  
 MINIMUM SPEED BOUNDARY 5 MPH  
 ZONE MAY BE ADJUSTED IN FIELD.

FOR SYSTEM TIMINGS, REFER TO SYSTEM PERMIT I-0003

**T-044**

PERMIT NUMBER: 8443 SHEET 2 OF 2  
 DATE ISSUED: 09-11-79 DATE REVISED: 3-25-13

**GENERAL NOTES**

INSTALLATION, OPERATION, AND MAINTENANCE OF THIS TRAFFIC SIGNAL TO BE IN ACCORDANCE WITH PENNSYLVANIA DEPARTMENT OF TRANSPORTATION REGULATIONS ON OFFICIAL TRAFFIC CONTROL DEVICES.  
 NO MODIFICATIONS OF THIS INSTALLATION ARE PERMITTED UNLESS PRIOR APPROVAL IS GRANTED, IN WRITING, BY THE DEPARTMENT.  
 ALL MAINTENANCE NECESSARY FOR PROPER VISIBILITY OF THE SIGNALS, INCLUDING TRIMMING TREES, IS THE RESPONSIBILITY OF THE PERMITTEE.  
 ALL SIGNS AND PAVEMENT MARKINGS INDICATED ON THIS DRAWING ARE CONSIDERED PART OF THE PERMIT AND ARE TO BE INSTALLED AND MAINTAINED BY THE PERMITTEE, UNLESS OTHERWISE INDICATED. EXCEPT THE LONGITUDINAL PAVEMENT MARKINGS ON STATE HIGHWAYS WHICH WILL BE MAINTAINED BY THE DEPARTMENT.  
 INSTALL POST MOUNTED SIGNALS WITH THE SIGNAL HEADS A MINIMUM OF 2 FEET BEHIND THE FACE OF THE CURB OR EDGE OF THE SHOULDER. SUPPORT POLES FOR OVERHEAD SIGNALS WILL HAVE A MINIMUM HORIZONTAL CLEARANCE OF 2 FEET.  
 THE BOTTOM OF SIGNAL HEADS AND SIGNS ERECTED OVER THE ROADWAY ARE NOT TO BE LESS THAN 15 FEET NOR MORE THAN 19 FEET ABOVE THE ROADWAY. THE BOTTOM OF POST MOUNTED SIGNAL HEADS ARE NOT TO BE LESS THAN 8 FEET NOR MORE THAN 15 FEET ABOVE THE SIDEWALK OR PAVEMENT GRADE.  
 THE MINIMUM HORIZONTAL DISTANCE BETWEEN SIGNAL HEADS MEASURED AT RIGHT ANGLES TO THE APPROACH IS TO BE 8 FEET.  
 PERMITTEE SHALL OBTAIN A HIGHWAY OCCUPANCY PERMIT FOR EMBANKMENT REMOVAL, CURBING AND/OR SIDEWALK, DRAINAGE STRUCTURES, CHANGES IN HIGHWAY GEOMETRY, PAVEMENT WIDENING, OR INSTALLATION OF ADDITIONAL LANES.  
 CONDUIT INSTALLED IN BITUMINOUS ROADWAY LESS THAN 5 YEARS OLD, OR CONCRETE ROADWAY REGARDLESS OF AGE, MUST BE BORED OR JACKED UNDER THE ROADWAY. INSTALL IN ACCORDANCE WITH TRAFFIC SIGNAL STANDARDS TC-8800 SERIES.  
 THIS DRAWING CANNOT BE USED AS A CONSTRUCTION DRAWING UNLESS THE PERMITTEE COMPLIES WITH THE PROVISIONS OF ACT 181, PREVENTION OF DAMAGE TO UNDERGROUND UTILITIES, EFFECTIVE MARCH 29, 2007.  
 PAVEMENT MARKINGS WILL BE PLACED IN ACCORDANCE WITH THE DEPARTMENT OF TRANSPORTATION PAVEMENT MARKING HANDBOOK.  
 PERMITTEE IS RESPONSIBLE FOR OBTAINING APPROVAL FOR INSTALLATION OF TRAFFIC SIGNAL DEVICES LOCATED OUTSIDE HIGHWAY RIGHT-OF-WAY.  
 TRAFFIC SIGNALS INSTALLED USING LIQUID FUELS TAX FUNDS MUST CONFORM TO DEPARTMENT SPECIFICATIONS AS SET FORTH IN CURRENT PUBLICATION 408, SUPPLEMENTS AND STANDARD DRAWINGS.

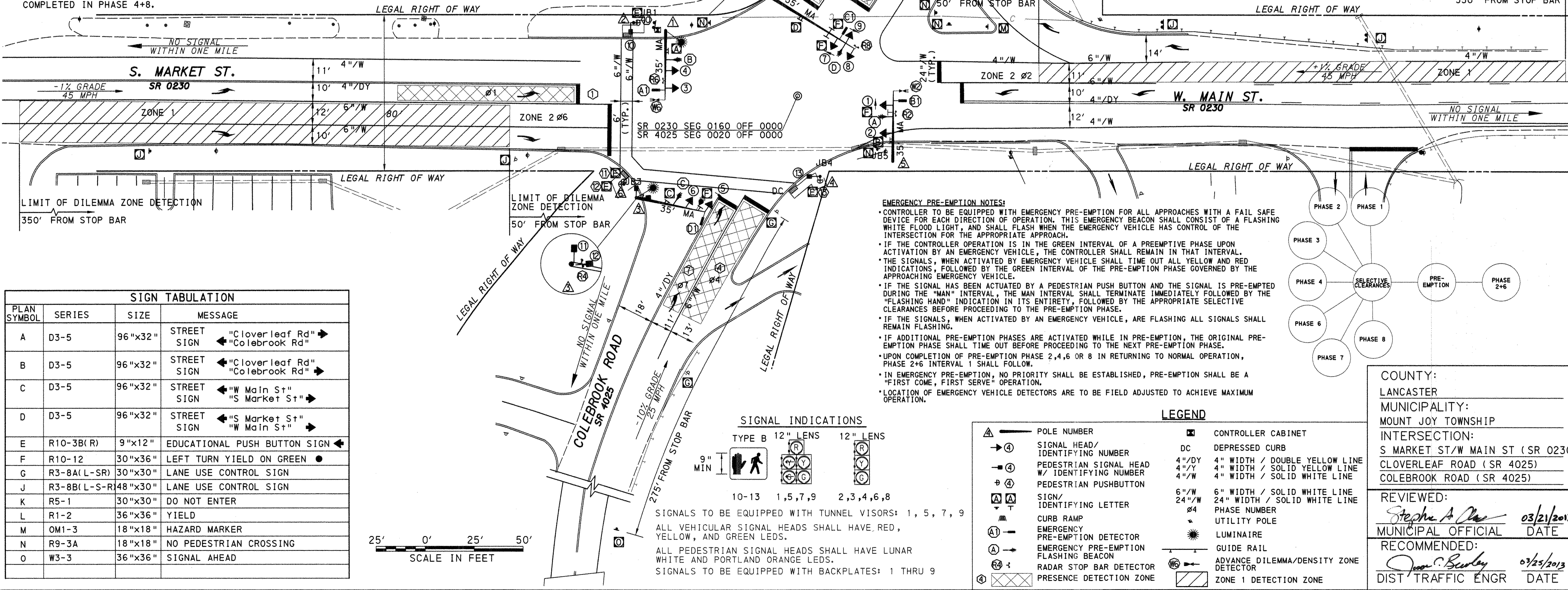

**SIGN TABULATION**

PLAN SYMBOL	SERIES	SIZE	MESSAGE
A	D3-5	96"x32"	STREET SIGN "Cloverleaf Rd" → ← "Colebrook Rd"
B	D3-5	96"x32"	STREET SIGN "Cloverleaf Rd" → ← "Colebrook Rd"
C	D3-5	96"x32"	STREET SIGN "W Main St" → ← "S Market St"
D	D3-5	96"x32"	STREET SIGN "S Market St" → ← "W Main St"
E	R10-3B(R)	9"x12"	EDUCATIONAL PUSH BUTTON SIGN ←
F	R10-12	30"x36"	LEFT TURN YIELD ON GREEN ●
G	R3-8A(L-SR)	30"x30"	LANE USE CONTROL SIGN
J	R3-8B(L-S-R)	48"x30"	LANE USE CONTROL SIGN
K	R5-1	30"x30"	DO NOT ENTER
L	R1-2	36"x36"	YIELD
M	OM1-3	18"x18"	HAZARD MARKER
N	R9-3A	18"x18"	NO PEDESTRIAN CROSSING
O	W3-3	36"x36"	SIGNAL AHEAD

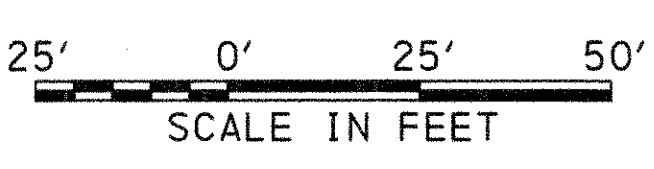

**SIGNAL INDICATIONS**

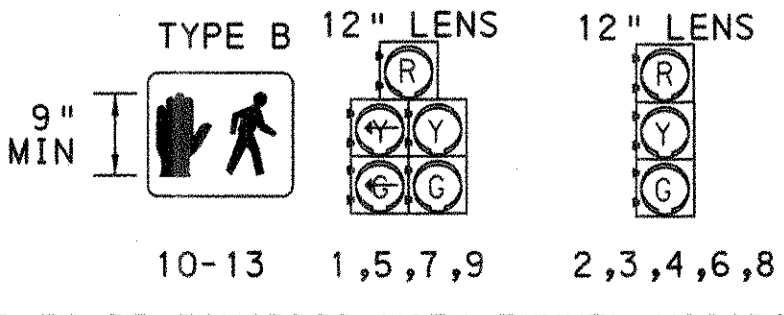

SIGNALS TO BE EQUIPPED WITH TUNNEL VISORS: 1, 5, 7, 9  
 ALL VEHICULAR SIGNAL HEADS SHALL HAVE RED, YELLOW, AND GREEN LEDS.  
 ALL PEDESTRIAN SIGNAL HEADS SHALL HAVE LUNAR WHITE AND PORTLAND ORANGE LEDS.  
 SIGNALS TO BE EQUIPPED WITH BACKPLATES: 1 THRU 9

**EMERGENCY PRE-EMPTION NOTES:**

- CONTROLLER TO BE EQUIPPED WITH EMERGENCY PRE-EMPTION FOR ALL APPROACHES WITH A FAIL SAFE DEVICE FOR EACH DIRECTION OF OPERATION. THIS EMERGENCY BEACON SHALL CONSIST OF A FLASHING WHITE FLOOD LIGHT, AND SHALL FLASH WHEN THE EMERGENCY VEHICLE HAS CONTROL OF THE INTERSECTION FOR THE APPROPRIATE APPROACH.
- IF THE CONTROLLER OPERATION IS IN THE GREEN INTERVAL OF A PREEMPTIVE PHASE UPON ACTIVATION BY AN EMERGENCY VEHICLE, THE CONTROLLER SHALL REMAIN IN THAT INTERVAL.
- THE SIGNALS, WHEN ACTIVATED BY EMERGENCY VEHICLE SHALL TIME OUT ALL YELLOW AND RED INDICATIONS, FOLLOWED BY THE GREEN INTERVAL OF THE PRE-EMPTION PHASE GOVERNED BY THE APPROACHING EMERGENCY VEHICLE.
- IF THE SIGNAL HAS BEEN ACTUATED BY A PEDESTRIAN PUSH BUTTON AND THE SIGNAL IS PRE-EMPTED DURING THE "MAN" INTERVAL, THE MAN INTERVAL SHALL TERMINATE IMMEDIATELY FOLLOWED BY THE "FLASHING HAND" INDICATION IN ITS ENTIRETY, FOLLOWED BY THE APPROPRIATE SELECTIVE CLEARANCES BEFORE PROCEEDING TO THE PRE-EMPTION PHASE.
- IF THE SIGNALS, WHEN ACTIVATED BY AN EMERGENCY VEHICLE, ARE FLASHING ALL SIGNALS SHALL REMAIN FLASHING.
- IF ADDITIONAL PRE-EMPTION PHASES ARE ACTIVATED WHILE IN PRE-EMPTION, THE ORIGINAL PRE-EMPTION PHASE SHALL TIME OUT BEFORE PROCEEDING TO THE NEXT PRE-EMPTION PHASE.
- UPON COMPLETION OF PRE-EMPTION PHASE 2, 4, 6, OR 8 IN RETURNING TO NORMAL OPERATION, PHASE 2+6 INTERVAL 1 SHALL FOLLOW.
- IN EMERGENCY PRE-EMPTION, NO PRIORITY SHALL BE ESTABLISHED, PRE-EMPTION SHALL BE A "FIRST COME, FIRST SERVE" OPERATION.
- LOCATION OF EMERGENCY VEHICLE DETECTORS ARE TO BE FIELD ADJUSTED TO ACHIEVE MAXIMUM OPERATION.

**LEGEND**

▲	POLE NUMBER	□	CONTROLLER CABINET
④	SIGNAL HEAD/ IDENTIFYING NUMBER	DC	DEPRESSED CURB
④	PEDESTRIAN SIGNAL HEAD W/ IDENTIFYING NUMBER	4"/DY	4" WIDTH / DOUBLE YELLOW LINE
④	PEDESTRIAN PUSHBUTTON	4"/Y	4" WIDTH / SOLID YELLOW LINE
④	SIGN/ IDENTIFYING LETTER	4"/W	4" WIDTH / SOLID WHITE LINE
④	CURB RAMP	6"/W	6" WIDTH / SOLID WHITE LINE
④	EMERGENCY PRE-EMPTION DETECTOR	24"/W	24" WIDTH / SOLID WHITE LINE
④	EMERGENCY PRE-EMPTION FLASHING BEACON	Ø4	PHASE NUMBER
④	RADAR STOP BAR DETECTOR	▲	UTILITY POLE
④	PRESENCE DETECTION ZONE	☼	LUMINAIRE
		—	GUIDE RAIL
		①⑥	ADVANCE DILEMMA/DENSITY ZONE DETECTOR
		▨	ZONE 1 DETECTION ZONE

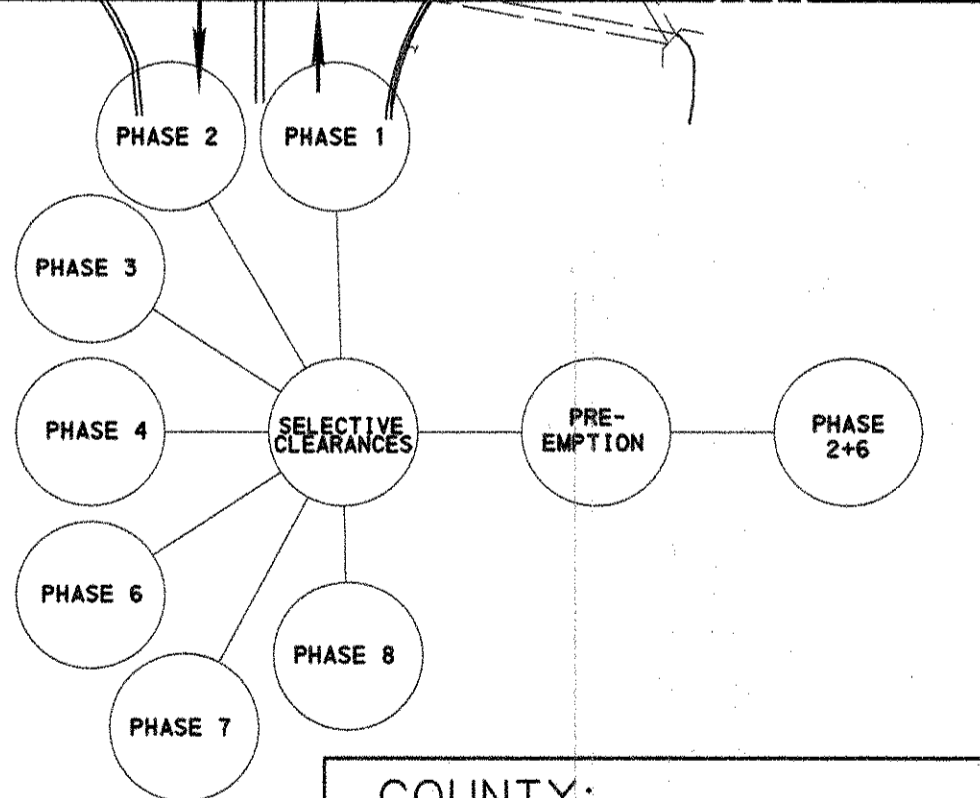

COUNTY: LANCASTER  
 MUNICIPALITY: MOUNT JOY TOWNSHIP  
 INTERSECTION: S MARKET ST/W MAIN ST (SR 0230)  
 CLOVERLEAF ROAD (SR 4025)  
 COLEBROOK ROAD (SR 4025)  
 REVIEWED: *Steph A. [Signature]* 03/21/2013  
 MUNICIPAL OFFICIAL DATE  
 RECOMMENDED: *Joan C. [Signature]* 03/25/2013  
 DIST TRAFFIC ENGR DATE

**MOVEMENT, SEQUENCE, AND TIMING DIAGRAM**

PHASE	2+6				4+8				PRE-EMP A			PRE-EMP C			PRE-EMP B			PRE-EMP D			EMERGENCY FLASHING	
	1	2	3	4	1	2	3	4	1	2	3	1	2	3	1	2	3	1	2	3		
SIGNAL INTERVAL	1,2	G	G	Y	R	R	R	R	R	G	Y	R	R	R	R	R	R	R	R	R	R	Y
3,4	G	G	Y	R	R	R	R	R	R	R	R	G	Y	R	R	R	R	R	R	R	Y	
5,6	R	R	R	R	G	G	Y	R	R	R	R	R	R	R	R	R	R	R	R	R	R	
7,8	R	R	R	R	G	G	Y	R	R	R	R	R	R	R	R	R	R	R	R	R	R	
9,10,11,12	M	FH	H	H	H	H	H	H	H	H	H	H	H	H	H	H	H	H	H	H	OFF	
13,14,15,16	H	H	H	H	M	FH	H	H	H	H	H	H	H	H	H	H	H	H	H	H	OFF	
FAIL-SAFE LAMP A																						
FAIL-SAFE LAMP B																						
FAIL-SAFE LAMP C																						
FAIL-SAFE LAMP D																						
SIGN G-RED	OFF	OFF	FR	SR	SR	SR	SR	SR	SR	SR	SR	SR	SR	SR	SR	SR	SR	SR	SR	SR	OFF	
SIGN G-SIGNAL AHEAD	ON	ON	ON	ON	ON	ON	ON	ON	ON	ON	ON	ON	ON	ON	ON	ON	ON	ON	ON	ON	ON	

FIXED	4.5	1.5	3	2.5	▲ 4.5	1.5	▲ 3	2.5	▲ 4.5	1.5	▲ 3	2.5
MINIMUM SEC / ACT	12	4	3									
MAXIMUM INITIAL PASSAGE	25											
TBR	6		3									
TTR	25											
MINIMUM GAP	3											
MAXIMUM 1	39		20									

**PRE-EMPTION OPERATION NOTES**  
 ① SIGNAL TO INDICATE G WHEN RETURNING TO NORMAL OPERATION  
 ▲ FOR DURATION OF PRE-EMPTION  
 \* UPON PEDESTRIAN ACTUATION OTHERWISE HAND SYMBOL AT ALL TIMES

**DETECTOR NOTES**  
 DETECTOR 2 CALLS AND EXTENDS PHASE 2 - PRESENCE  
 DETECTOR 6 CALLS AND EXTENDS PHASE 6 - PRESENCE  
 DETECTION ZONE 4a CALLS AND EXTENDS PHASE 4 - PRESENCE  
 DETECTION ZONE 4b CALLS AND EXTENDS PHASE 4 - PRESENCE (5 SECOND DELAY)  
 DETECTOR 8a CALLS AND EXTENDS PHASE 8 - PRESENCE (5 SECOND DELAY)

**EMERGENCY PRE-EMPTION NOTES:**  
 CONTROLLER TO BE EQUIPPED WITH EMERGENCY PRE-EMPTION EQUIPMENT FOR ALL APPROACHES OF ANDREW AVENUE WHICH SHALL PROVIDE A SELECTIVE YELLOW INTERVAL, A GREEN INDICATION WILL BE GIVEN TO THE PRE-EMPTED APPROACH AND A RED INDICATION ON ALL OTHER APPROACHES.  
 EMERGENCY PRE-EMPTION MAY OCCUR DURING ANY INTERVAL OF THE NORMAL CONTROLLER OPERATIONS. DEPENDING ON THE DIRECTION OF TRAVEL OF THE EMERGENCY VEHICLE, ONE OF THE FOLLOWING PHASES SHALL BE CALLED: EMERGENCY PRE-EMPTION PHASE A, PHASE B, PHASE C, OR PHASE D. THE SYSTEM SHALL PROVIDE SERVICE ON A FIRST-COME, FIRST-SERVE BASIS. ONCE THE FIRST PRIORITY VEHICLE CALLS THE SYSTEM, IT SHALL PREVENT OTHER PREEMPTIVE VEHICLES FROM ENTERING CALLS UNTIL THE FIRST EMERGENCY VEHICLE RELEASES CONTROL AND CLEARS THE INTERSECTION.  
 IF THE CONTROLLER OPERATION IS IN THE GREEN INTERVAL OF A NON-PREEMPTIVE VEHICLE PHASE, UPON ACTIVATION BY AN EMERGENCY VEHICLE, THE CONTROLLER SHALL TERMINATE THE INTERVAL IMMEDIATELY AND PROCEED NORMALLY THROUGH THE YELLOW AND ALL RED INTERVALS BEFORE PROCEEDING TO THE PREEMPTIVE PHASE.  
 IF THE CONTROLLER OPERATION IS IN THE GREEN INTERVAL OF A PREEMPTIVE PHASE, UPON ACTIVATION BY AN EMERGENCY VEHICLE, THE CONTROLLER SHALL REMAIN IN THAT INTERVAL.  
 IF THE CONTROLLER OPERATION IS IN THE YELLOW, YELLOW ARROW, OR ALL RED INTERVAL OF ANY VEHICLE PHASE, UPON ACTIVATION BY AN EMERGENCY VEHICLE, THE CONTROLLER SHALL TIME OUT OF THOSE INTERVALS NORMALLY AND PROCEED TO THE PREEMPTION PHASE.  
 THE GREEN INTERVAL SHALL EXTEND FOR THE LENGTH OF THE PREEMPTION ACTUATION BUT SHALL BE A MAXIMUM OF 30 SECONDS FOR EACH EMERGENCY PREEMPTION PHASE. UPON TERMINATION OF THE PREEMPTION PHASE, THE CONTROLLER SHALL PROCEED NORMALLY THROUGH THE YELLOW, YELLOW ARROW, AND ALL RED INTERVALS TO THE PRE-DESIGNATED POST PREEMPTION PHASE, THEN TO NORMAL "PHASE NEXT" OPERATION.

**GENERAL NOTES FOR "RED SIGNAL AHEAD" SIGN**  
 1. INTERNALLY ILLUMINATED "RED SIGNAL AHEAD" SIGN SHALL BE LED.  
 2. THE LED LAMPS SHALL BE ARRANGED SO THAT FAILURE OF ONE LAMP WILL NOT EXTINGUISH THE LINE OF THE MESSAGE OR A PORTION THEREOF.  
 3. THE WORD "RED" SHALL NOT BE VISIBLE DURING THE GREEN INTERVAL. "SIGNAL AHEAD" SHALL BE CONTINUOUSLY ILLUMINATED.  
 4. THE SIGN CASE SHALL BE FULLY GASKETED AND WATER TIGHT.  
 5. PROVIDE HINGE AND ALL HARDWARE OF STAINLESS STEEL.  
 6. CLAMPS AND ALL CONNECTING HARDWARE SHALL BE PROVIDED FOR MOUNTING ON SHAFT OF PEDESTAL OR OVERHEAD ON MAST ARM.  
**"SIGNAL AHEAD" OPERATIONAL NOTES**  
 A. DURING INTERVAL 3 (PHASE 2+6) THE WORD "RED" SHALL BE IN THE FLASHING MODE.  
 B. THE "RED" SHALL BE STEADY BURN RED DURING INTERVAL 4 (PHASE 2+6) AND 1,2,3,4 (PHASE 4+8).

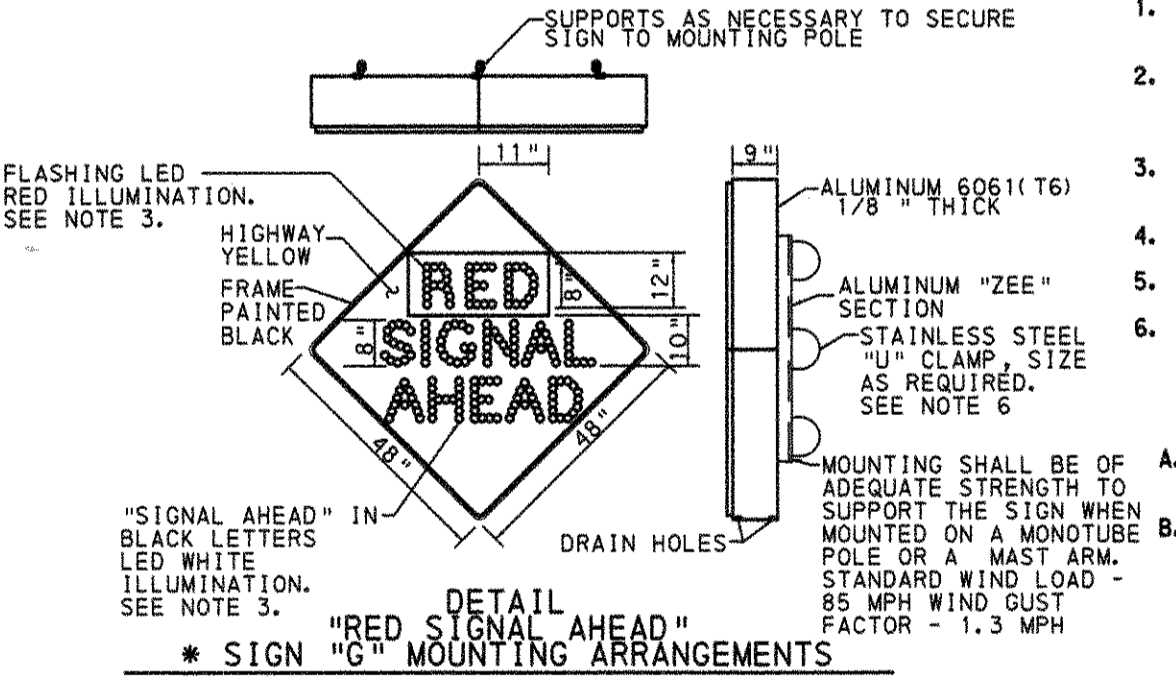

**SIGN TABULATION**

PLAN SYMBOL	SERIES	SIZE	MESSAGE
Ⓐ	D3-4	84"x16"	STREET SIGN "Cloverleaf Rd"
Ⓑ	D3-5	96"x28"	STREET SIGN "← Andrew Ave"
Ⓒ	D3-5	96"x28"	STREET SIGN "← Norlanco Dr →"
Ⓓ	R3-8A(LS-R)	30"x30"	LANE USE CONTROL SIGN
Ⓔ	R10-6AL	24"x30"	STOP HERE ON RED
Ⓕ	R10-4B(L/R)	9"x12"	EDUCATIONAL PUSH BUTTON SIGN ←OR→
Ⓖ	SPECIAL	48"x48"	SIGNAL RED AHEAD

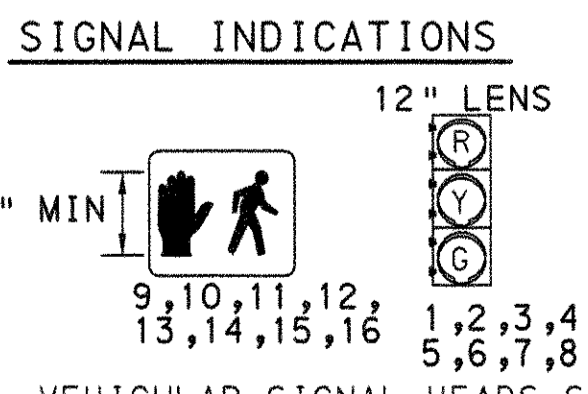

ALL VEHICULAR SIGNAL HEADS SHALL HAVE RED, YELLOW, AND GREEN LEADS.  
 SIGNALS TO BE EQUIPPED WITH BACKPLATES 1-8

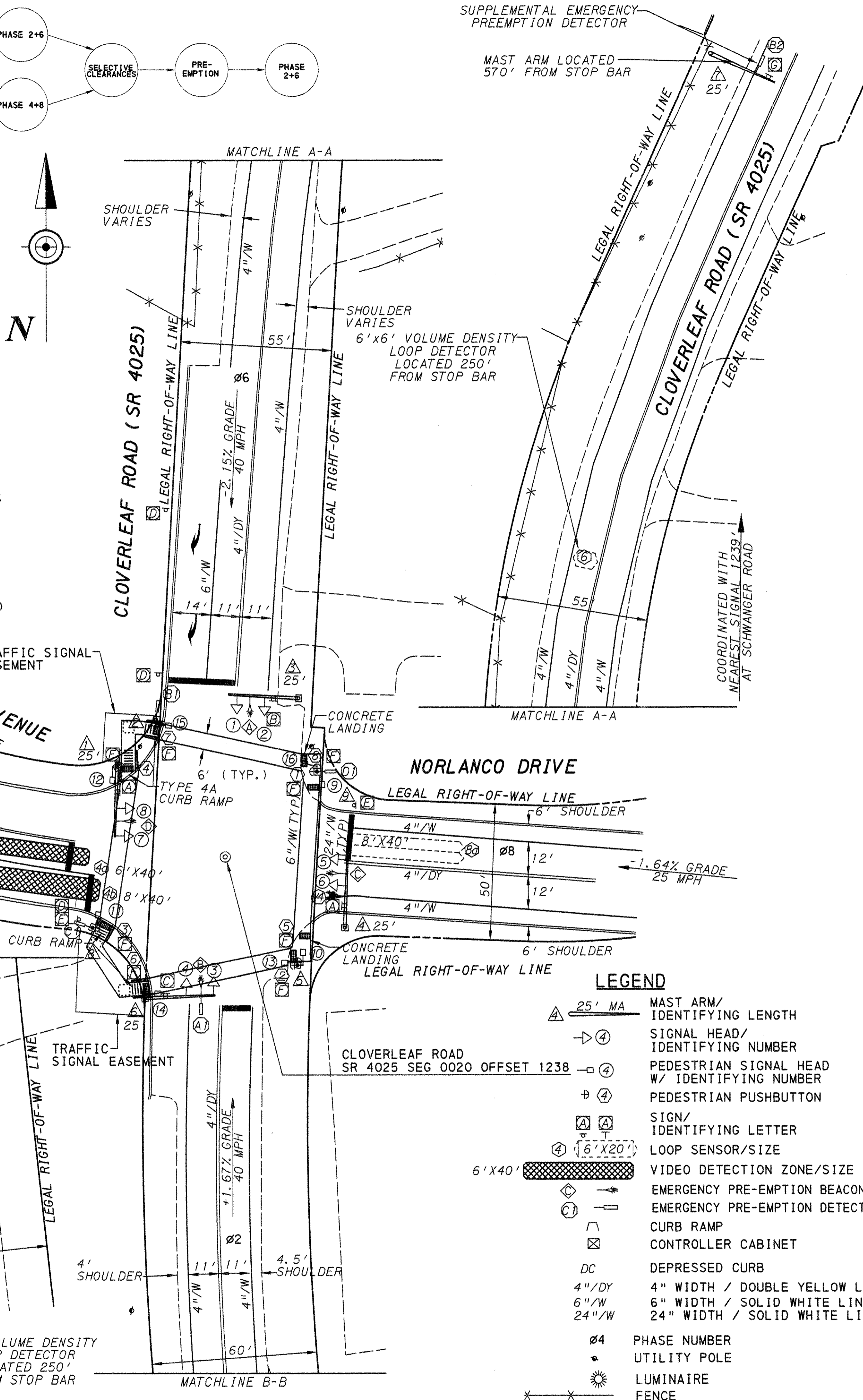

SUPPLEMENTAL EMERGENCY PREEMPTION DETECTOR  
 MAST ARM LOCATED 570' FROM STOP BAR

PERMIT NUMBER: 87-259 SHEET 2 OF 2  
 DATE ISSUED: 04-30-2007 DATE REVISED: 8-25-11

# T-272

**GENERAL NOTES**

INSTALLATION, OPERATION, AND MAINTENANCE OF THIS TRAFFIC SIGNAL TO BE IN ACCORDANCE WITH PENNSYLVANIA DEPARTMENT OF TRANSPORTATION REGULATIONS ON OFFICIAL TRAFFIC CONTROL DEVICES.  
 NO MODIFICATIONS OF THIS INSTALLATION ARE PERMITTED UNLESS PRIOR APPROVAL IS GRANTED, IN WRITING, BY THE DEPARTMENT.  
 ALL MAINTENANCE NECESSARY FOR PROPER VISIBILITY OF THE SIGNALS, INCLUDING TRIMMING TREES, IS THE RESPONSIBILITY OF THE PERMITEE.  
 ALL SIGNS AND PAVEMENT MARKINGS INDICATED ON THIS DRAWING ARE CONSIDERED PART OF THE PERMIT AND ARE TO BE INSTALLED AND MAINTAINED BY THE PERMITEE, UNLESS OTHERWISE INDICATED. EXCEPT THE LONGITUDINAL PAVEMENT MARKINGS ON STATE HIGHWAYS WHICH WILL BE MAINTAINED BY THE DEPARTMENT.  
 INSTALL POST MOUNTED SIGNALS WITH THE SIGNAL HEADS A MINIMUM OF 2 FEET BEHIND THE FACE OF THE CURB OR EDGE OF THE SHOULDER. SUPPORT POLES FOR OVERHEAD SIGNALS WILL HAVE A MINIMUM HORIZONTAL CLEARANCE OF 2 FEET.  
 THE BOTTOM OF SIGNAL HEADS AND SIGNS ERECTED OVER THE ROADWAY ARE NOT TO BE LESS THAN 15 FEET NOR MORE THAN 19 FEET ABOVE THE ROADWAY. THE BOTTOM OF POST MOUNTED SIGNAL HEADS ARE NOT TO BE LESS THAN 8 FEET NOR MORE THAN 15 FEET ABOVE THE SIDEWALK OR PAVEMENT GRADE.  
 THE MINIMUM HORIZONTAL DISTANCE BETWEEN SIGNAL HEADS MEASURED AT RIGHT ANGLES TO THE APPROACH IS TO BE 8 FEET.  
 PERMITEE SHALL OBTAIN A HIGHWAY OCCUPANCY PERMIT FOR EMBANKMENT REMOVAL, CURBING AND/OR SIDEWALK, DRAINAGE STRUCTURES, CHANGES IN HIGHWAY GEOMETRY, PAVEMENT WIDENING, OR INSTALLATION OF ADDITIONAL LANES.  
 CONDUIT INSTALLED IN BITUMINOUS ROADWAY LESS THAN 5 YEARS OLD, OR CONCRETE ROADWAY REGARDLESS OF AGE, MUST BE BORED OR JACKED UNDER THE ROADWAY. INSTALL IN ACCORDANCE WITH TRAFFIC SIGNAL STANDARDS TC-7800 SERIES.  
 THIS DRAWING CANNOT BE USED AS A CONSTRUCTION DRAWING UNLESS THE PERMITEE COMPLIES WITH THE PROVISIONS OF ACT 199, PREVENTION OF DAMAGE TO UNDERGROUND UTILITIES, EFFECTIVE NOVEMBER 30, 2004 PRIOR TO CONSTRUCTION CONSULT WITH UTILITY COMPANIES TO RESOLVE ANY PROBLEMS WHICH MAY BE CREATED DUE TO THE LOCATION OF UTILITIES.  
 PAVEMENT MARKINGS WILL BE PLACED IN ACCORDANCE WITH THE DEPARTMENT OF TRANSPORTATION PAVEMENT MARKING HANDBOOK.  
 PERMITEE IS RESPONSIBLE FOR OBTAINING APPROVAL FOR INSTALLATION OF TRAFFIC SIGNAL DEVICES LOCATED OUTSIDE HIGHWAY RIGHT-OF-WAY.  
 TRAFFIC SIGNALS INSTALLED USING LIQUID FUELS TAX FUNDS MUST CONFORM TO DEPARTMENT SPECIFICATIONS AS SET FORTH IN CURRENT PUBLICATION 408, SUPPLEMENTS AND STANDARD DRAWINGS.

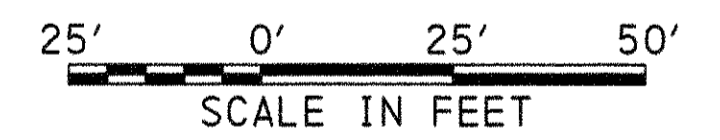

**COUNTY:** LANCASTER COUNTY  
**MUNICIPALITY:** MOUNT JOY TOWNSHIP  
**INTERSECTION:** CLOVERLEAF ROAD (SR 4025) ANDREW AVENUE, AND NORLANCO DRIVE

**REVIEWED:**  
 [Signature] 8/1/2011  
 MUNICIPAL OFFICIAL DATE  
**RECOMMENDED:**  
 [Signature] 08/25/2011  
 DIST TRAFFIC ENGR DATE

C:\Traffic\Signal\Intersections\T-272 Cloverleaf Road & Andrew Avenue\3011-07-29 permit1 rev\station\08permit1-Andrew.dgn  
 7/28/2011 4:22:07 PM

T-273

**GENERAL NOTES**

INSTALLATION, OPERATION, AND MAINTENANCE OF THIS TRAFFIC SIGNAL TO BE IN ACCORDANCE WITH PENNSYLVANIA DEPARTMENT OF TRANSPORTATION REGULATIONS ON OFFICIAL TRAFFIC CONTROL DEVICES.

NO MODIFICATIONS OF THIS INSTALLATION ARE PERMITTED UNLESS PRIOR APPROVAL IS GRANTED, IN WRITING, BY THE DEPARTMENT.

ALL MAINTENANCE NECESSARY FOR PROPER VISIBILITY OF THE SIGNALS, INCLUDING TRIMMING TREES, IS THE RESPONSIBILITY OF THE PERMITTEE.

ALL SIGNS AND PAVEMENT MARKINGS INDICATED ON THIS DRAWING ARE CONSIDERED PART OF THE PERMIT AND ARE TO BE INSTALLED AND MAINTAINED BY THE PERMITTEE, UNLESS OTHERWISE INDICATED. EXCEPT THE LONGITUDINAL PAVEMENT MARKINGS ON STATE HIGHWAYS WHICH WILL BE MAINTAINED BY THE DEPARTMENT.

INSTALL POST MOUNTED SIGNALS WITH THE SIGNAL HEADS A MINIMUM OF 2 FEET BEHIND THE FACE OF THE CURB OR EDGE OF THE SHOULDER. SUPPORT POLES FOR OVERHEAD SIGNALS WILL HAVE A MINIMUM HORIZONTAL CLEARANCE OF 2 FEET.

THE BOTTOM OF SIGNAL HEADS AND SIGNS ERECTED OVER THE ROADWAY ARE NOT TO BE LESS THAN 15 FEET NOR MORE THAN 19 FEET ABOVE THE ROADWAY. THE BOTTOM OF POST MOUNTED SIGNAL HEADS ARE NOT TO BE LESS THAN 8 FEET NOR MORE THAN 15 FEET ABOVE THE SIDEWALK OR PAVEMENT GRADE.

THE MINIMUM HORIZONTAL DISTANCE BETWEEN SIGNAL HEADS MEASURED AT RIGHT ANGLES TO THE APPROACH IS TO BE 8 FEET.

PERMITTEE SHALL OBTAIN A HIGHWAY OCCUPANCY PERMIT FOR EMBANKMENT REMOVAL, CURBING AND/OR SIDEWALK, DRAINAGE STRUCTURES, CHANGES IN HIGHWAY GEOMETRY, PAVEMENT WIDENING, OR INSTALLATION OF ADDITIONAL LANES.

CONDUIT INSTALLED IN BITUMINOUS ROADWAY LESS THAN 5 YEARS OLD, OR CONCRETE ROADWAY REGARDLESS OF AGE, MUST BE BORED OR JACKED UNDER THE ROADWAY. INSTALL IN ACCORDANCE WITH TRAFFIC SIGNAL STANDARDS TC-7800 SERIES.

THIS DRAWING CANNOT BE USED AS A CONSTRUCTION DRAWING UNLESS THE PERMITTEE COMPLIES WITH THE PROVISIONS OF ACT 199, PREVENTION OF DAMAGE TO UNDERGROUND UTILITIES, EFFECTIVE NOVEMBER 30, 2004 PRIOR TO CONSTRUCTION CONSULT WITH UTILITY COMPANIES TO RESOLVE ANY PROBLEMS WHICH MAY BE CREATED DUE TO THE LOCATION OF UTILITIES.

PAVEMENT MARKINGS WILL BE PLACED IN ACCORDANCE WITH THE DEPARTMENT OF TRANSPORTATION PAVEMENT MARKING HANDBOOK.

PERMITTEE IS RESPONSIBLE FOR OBTAINING APPROVAL FOR INSTALLATION OF TRAFFIC SIGNAL DEVICES LOCATED OUTSIDE HIGHWAY RIGHT-OF-WAY.

TRAFFIC SIGNALS INSTALLED USING LIQUID FUELS TAX FUNDS MUST CONFORM TO DEPARTMENT SPECIFICATIONS AS SET FORTH IN CURRENT PUBLICATION 408, SUPPLEMENTS AND STANDARD DRAWINGS.

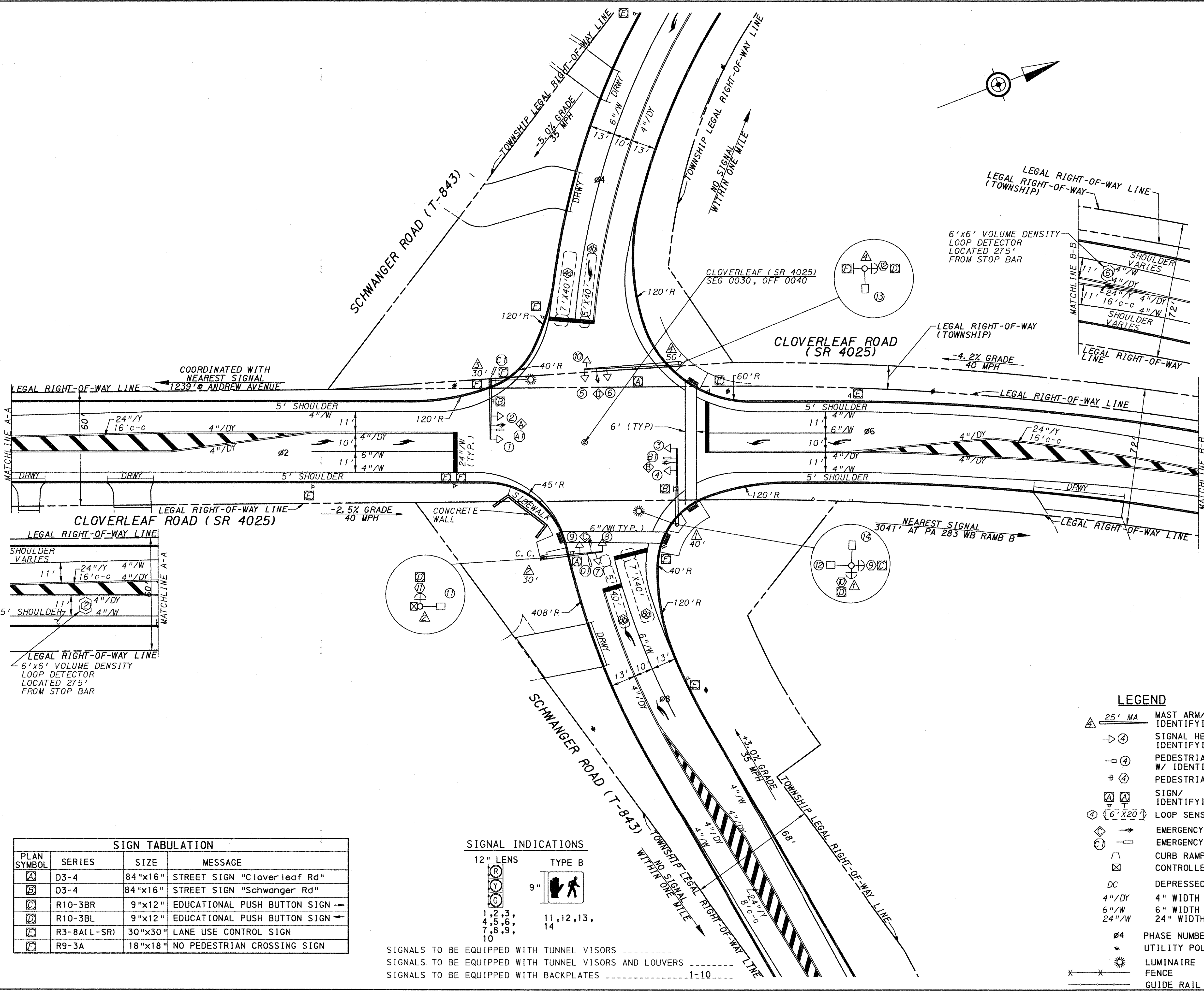

J:\MUTD\00013 (SR 4025-007) XADDP (on 9) perm1.dgn 5/29/2008 8:54:41 AM vgl:rev10 Traffic Planning and Design, Inc.

SIGN TABULATION			
PLAN SYMBOL	SERIES	SIZE	MESSAGE
(A)	D3-4	84"x16"	STREET SIGN "Cloverleaf Rd"
(B)	D3-4	84"x16"	STREET SIGN "Schwanger Rd"
(C)	R10-3BR	9"x12"	EDUCATIONAL PUSH BUTTON SIGN →
(D)	R10-3BL	9"x12"	EDUCATIONAL PUSH BUTTON SIGN ←
(E)	R3-8A(L-SR)	30"x30"	LANE USE CONTROL SIGN
(F)	R9-3A	18"x18"	NO PEDESTRIAN CROSSING SIGN

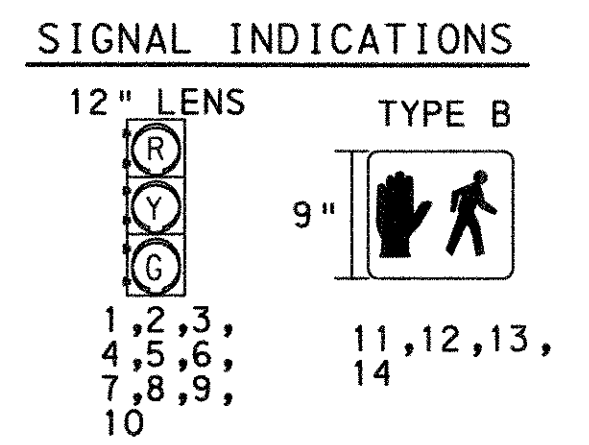

SIGNALS TO BE EQUIPPED WITH TUNNEL VISORS -----  
 SIGNALS TO BE EQUIPPED WITH TUNNEL VISORS AND LOUVERS -----  
 SIGNALS TO BE EQUIPPED WITH BACKPLATES ----- 1-10

- LEGEND**
- △ 25' MA MAST ARM/ IDENTIFYING LENGTH
  - ▷ ④ SIGNAL HEAD/ IDENTIFYING NUMBER
  - ◻ ④ PEDESTRIAN SIGNAL HEAD W/ IDENTIFYING NUMBER
  - ⊕ ④ PEDESTRIAN PUSHBUTTON
  - ⓐ ④ SIGN/ IDENTIFYING LETTER
  - ④ (6'x20') LOOP SENSOR/SIZE
  - ⊕ EMERGENCY PRE-EMPTION BEACON
  - ⊕ EMERGENCY PRE-EMPTION DETECTOR
  - ⓐ CURB RAMP
  - ⓐ CONTROLLER CABINET
  - DC DEPRESSED CURB
  - 4"/DY 4" WIDTH / DOUBLE YELLOW LINE
  - 6"/W 6" WIDTH / SOLID WHITE LINE
  - 24"/W 24" WIDTH / SOLID WHITE LINE
  - ⊕ UTILITY POLE
  - ☀ LUMINAIRE
  - × × FENCE
  - — — — — GUIDE RAIL

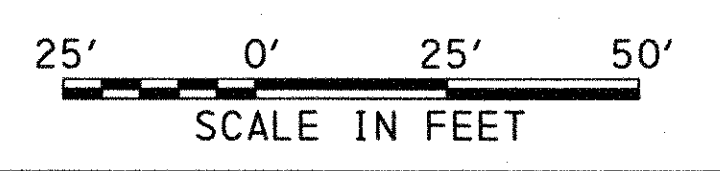

**COUNTY:** LANCASTER COUNTY  
**MUNICIPALITY:** MOUNT JOY TOWNSHIP  
**INTERSECTION:** CLOVERLEAF ROAD (SR 4025) AND SCHWANGER ROAD (T-843)

**REVIEWED:** Robert W. [Signature] 5/15/08  
**MUNICIPAL OFFICIAL DATE**

**APPROVED:** Jason C. [Signature] 05/21/08  
**DIST TRAFFIC ENGR DATE**

MOVEMENT, SEQUENCE, AND TIMING DIAGRAM

PHASE	2+6				4+8				PRE-EMP PHASE A				PRE-EMP PHASE B				PRE-EMP PHASE C				PRE-EMP PHASE D				EMERGENCY FLASHING								
	1	2	3	4	1	2	3	4	1	2	3	4	1	2	3	4	1	2	3	4	1	2	3	4									
SIGNAL INTERVAL	G	G	Y	R	R	R	R	R	G	Y	R	R	R	R	R	R	G	Y	R	R	R	R	R	R	G	Y	R	R	R	R	R	R	Y
1,2	G	G	Y	R	R	R	R	R	R	R	R	R	R	R	R	R	R	R	R	R	R	R	R	R	R	R	R	R	R	R	R	R	Y
3,4	G	G	Y	R	R	R	R	R	R	R	R	R	R	R	R	R	R	R	R	R	R	R	R	R	R	R	R	R	R	R	R	R	Y
5,6,7	R	R	R	R	G	G	Y	R	R	R	R	R	R	R	R	R	R	R	R	R	R	R	R	R	R	R	R	R	R	R	R	R	Y
8,9,10	R	R	R	R	G	G	Y	R	R	R	R	R	R	R	R	R	R	R	R	R	R	R	R	R	R	R	R	R	R	R	R	R	Y
11,12	M	FH	H	H	H	H	H	H	H	H	H	H	H	H	H	H	H	H	H	H	H	H	H	H	H	H	H	H	H	H	H	H	OFF
13,14	H	H	H	H	M	FH	H	H	H	H	H	H	H	H	H	H	H	H	H	H	H	H	H	H	H	H	H	H	H	H	H	H	OFF
FAIL-SAFE LAMP	OFF	OFF	OFF	OFF	OFF	OFF	OFF	OFF	OFF	ON	OFF	OFF	OFF	ON	OFF	OFF	OFF	ON	OFF	OFF	OFF	ON	OFF	OFF	OFF	ON	OFF	OFF	OFF	ON	OFF	OFF	OFF
FIXED			4.5	2			4	2	▲	4.5	2		▲	4.5	2		▲	4	2		▲	4	2		▲	4	2		▲	4	2		
MINIMUM	12						3																										
SEC / ACT	3																																
MAXIMUM INITIAL	28																																
PASSAGE	6						3																										
TIME BEFORE REDUCTION	14																																
TIME TO REDUCTION	14																																
MINIMUM GAP	3																																
MAXIMUM 1	56						23																										
MAXIMUM 2																																	
PEDESTRIAN	②	14	16				11	12																									
MEMORY			MIN-RECALL				NON-LOCK																										

▲ FOR DURATION OF PRE-EMPTION

• THIS SIGNAL TO BE COORDINATED WITH THE FOLLOWING SIGNALS ALONG CLOVERLEAF ROAD (S.R. 4025) AT: ANDREW AVENUE AND ROUTE 230 VIA GPS TIME CLOCKS

PRE-EMPTION OPERATION NOTES

① SIGNAL TO INDICATE G WHEN RETURNING TO NORMAL OPERATION

OPERATION NOTES

② UPON PEDESTRIAN ACTUATION ONLY

DETECTOR NOTES

DETECTOR 10 AND 11 CALL PED SIGNALS FOR PHASE 2+6  
 DETECTOR 9 AND 12 CALL PED SIGNALS FOR PHASE 4+8  
 DETECTOR 4a, 4b, 8a AND 8b CALL AND EXTEND PHASE 4+8 PRESENCE  
 DETECTOR 2 AND 6 CALL AND EXTEND PHASE 2+6 PRESENCE

EMERGENCY PRE-EMPTION

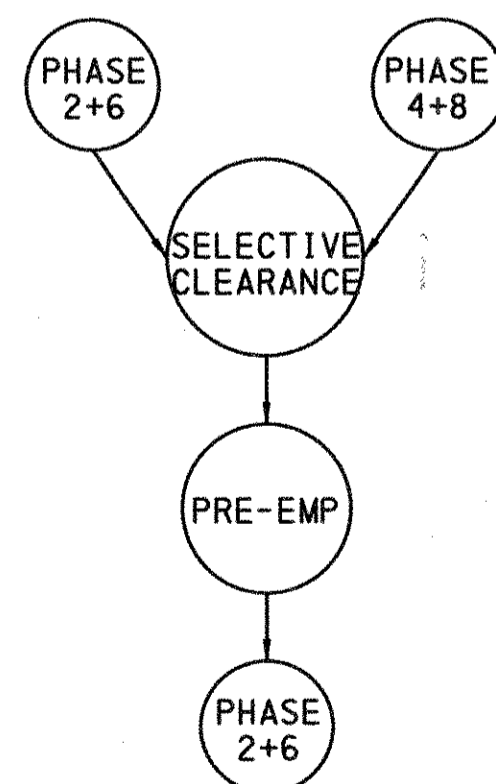

EMERGENCY PRE-EMPTION NOTES:

CONTROLLER TO BE EQUIPPED WITH EMERGENCY PRE-EMPTION EQUIPMENT FOR BOTH THE NORTHBOUND AND SOUTHBOUND APPROACHES OF CLOVERLEAF ROAD (SR 4025) AND THE EASTBOUND AND WESTBOUND APPROACHES OF SCHWANGER ROAD WHICH SHALL PROVIDE A SELECTIVE YELLOW INTERVAL, A GREEN INDICATION WILL BE GIVEN TO THE PRE-EMPTED APPROACH AND A RED INDICATION ON ALL OTHER APPROACHES.

EMERGENCY PREEMPTION MAY OCCUR DURING ANY INTERVAL OF THE NORMAL CONTROLLER OPERATIONS. DEPENDING ON THE DIRECTION OF TRAVEL OF THE EMERGENCY VEHICLE, ONE OF THE FOLLOWING PHASES SHALL BE CALLED: EMERGENCY PREEMPTION PHASE A, PHASE B, PHASE C, OR PHASE D. THE SYSTEM SHALL PROVIDE SERVICE ON A FIRST-COME, FIRST-SERVE BASIS. ONCE THE FIRST PRIORITY VEHICLE CALLS THE SYSTEM, IT SHALL PREVENT OTHER PREEMPTIVE VEHICLES FROM ENTERING CALLS UNTIL THE FIRST EMERGENCY VEHICLE RELEASES CONTROL AND CLEARS THE INTERSECTION.

IF THE CONTROLLER OPERATION IS IN THE GREEN INTERVAL OF A NON-PREEMPTIVE VEHICLE PHASE, UPON ACTIVATION BY AN EMERGENCY VEHICLE, THE CONTROLLER SHALL TERMINATE THE INTERVAL IMMEDIATELY AND PROCEED NORMALLY THROUGH THE YELLOW AND ALL RED INTERVALS BEFORE PROCEEDING TO THE PREEMPTIVE PHASE.

IF THE CONTROLLER OPERATION IS IN THE GREEN INTERVAL OF A PREEMPTIVE PHASE, UPON ACTIVATION BY AN EMERGENCY VEHICLE, THE CONTROLLER SHALL REMAIN IN THAT INTERVAL.

IF THE CONTROLLER OPERATION IS IN THE YELLOW, YELLOW ARROW, OR ALL RED INTERVAL OF ANY VEHICLE PHASE, UPON ACTIVATION BY AN EMERGENCY VEHICLE, THE CONTROLLER SHALL TIME OUT OF THOSE INTERVALS NORMALLY AND PROCEED TO THE PREEMPTION PHASE.

THE GREEN INTERVAL SHALL EXTEND FOR THE LENGTH OF THE PREEMPTION ACTUATION BUT SHALL BE A MAXIMUM OF 30 SECONDS FOR EACH EMERGENCY PREEMPTION PHASE. UPON TERMINATION OF THE PREEMPTION PHASE, THE CONTROLLER SHALL PROCEED NORMALLY THROUGH THE YELLOW, YELLOW ARROW, AND ALL RED INTERVALS TO THE PRE-DESIGNATED POST PREEMPTION PHASE, THEN TO NORMAL "PHASE NEXT" OPERATION.

T-273

GENERAL NOTES

INSTALLATION, OPERATION, AND MAINTENANCE OF THIS TRAFFIC SIGNAL TO BE IN ACCORDANCE WITH PENNSYLVANIA DEPARTMENT OF TRANSPORTATION REGULATIONS ON OFFICIAL TRAFFIC CONTROL DEVICES.

NO MODIFICATIONS OF THIS INSTALLATION ARE PERMITTED UNLESS PRIOR APPROVAL IS GRANTED, IN WRITING, BY THE DEPARTMENT.

ALL MAINTENANCE NECESSARY FOR PROPER VISIBILITY OF THE SIGNALS, INCLUDING TRIMMING TREES, IS THE RESPONSIBILITY OF THE PERMITTEE.

ALL SIGNS AND PAVEMENT MARKINGS INDICATED ON THIS DRAWING ARE CONSIDERED PART OF THE PERMIT AND ARE TO BE INSTALLED AND MAINTAINED BY THE PERMITTEE, UNLESS OTHERWISE INDICATED. EXCEPT THE LONGITUDINAL PAVEMENT MARKINGS ON STATE HIGHWAYS WHICH WILL BE MAINTAINED BY THE DEPARTMENT.

INSTALL POST MOUNTED SIGNALS WITH THE SIGNAL HEADS A MINIMUM OF 2 FEET BEHIND THE FACE OF THE CURB OR EDGE OF THE SHOULDER. SUPPORT POLES FOR OVERHEAD SIGNALS WILL HAVE A MINIMUM HORIZONTAL CLEARANCE OF 2 FEET.

THE BOTTOM OF SIGNAL HEADS AND SIGNS ERECTED OVER THE ROADWAY ARE NOT TO BE LESS THAN 15 FEET NOR MORE THAN 19 FEET ABOVE THE ROADWAY. THE BOTTOM OF POST MOUNTED SIGNAL HEADS ARE NOT TO BE LESS THAN 8 FEET NOR MORE THAN 15 FEET ABOVE THE SIDEWALK OR PAVEMENT GRADE.

THE MINIMUM HORIZONTAL DISTANCE BETWEEN SIGNAL HEADS MEASURED AT RIGHT ANGLES TO THE APPROACH IS TO BE 8 FEET.

PERMITTEE SHALL OBTAIN A HIGHWAY OCCUPANCY PERMIT FOR EMBANKMENT REMOVAL, CURBING AND/OR SIDEWALK, DRAINAGE STRUCTURES, CHANGES IN HIGHWAY GEOMETRY, PAVEMENT WIDENING, OR INSTALLATION OF ADDITIONAL LANES.

CONDUIT INSTALLED IN BITUMINOUS ROADWAY LESS THAN 5 YEARS OLD, OR CONCRETE ROADWAY REGARDLESS OF AGE, MUST BE BORED OR JACKED UNDER THE ROADWAY. INSTALL IN ACCORDANCE WITH TRAFFIC SIGNAL STANDARDS TC-7800 SERIES.

THIS DRAWING CANNOT BE USED AS A CONSTRUCTION DRAWING UNLESS THE PERMITTEE COMPLIES WITH THE PROVISIONS OF ACT 199, PREVENTION OF DAMAGE TO UNDERGROUND UTILITIES, EFFECTIVE NOVEMBER 30, 2004 PRIOR TO CONSTRUCTION CONSULT WITH UTILITY COMPANIES TO RESOLVE ANY PROBLEMS WHICH MAY BE CREATED DUE TO THE LOCATION OF UTILITIES.

PAVEMENT MARKINGS WILL BE PLACED IN ACCORDANCE WITH THE DEPARTMENT OF TRANSPORTATION PAVEMENT MARKING HANDBOOK.

PERMITTEE IS RESPONSIBLE FOR OBTAINING APPROVAL FOR INSTALLATION OF TRAFFIC SIGNAL DEVICES LOCATED OUTSIDE HIGHWAY RIGHT-OF-WAY.

TRAFFIC SIGNALS INSTALLED USING LIQUID FUELS TAX FUNDS MUST CONFORM TO DEPARTMENT SPECIFICATIONS AS SET FORTH IN CURRENT PUBLICATION 408, SUPPLEMENTS AND STANDARD DRAWINGS.

LEGEND

- ▲ 25' MA MAST ARM/ IDENTIFYING LENGTH
- ④ SIGNAL HEAD/ IDENTIFYING NUMBER
- ④ PEDESTRIAN SIGNAL HEAD W/ IDENTIFYING NUMBER
- ⊕ ④ PEDESTRIAN PUSHBUTTON
- ⓐ ④ SIGN/ IDENTIFYING LETTER
- ④ (6' X 20') LOOP SENSOR/SIZE
- Ⓧ → EMERGENCY PRE-EMPTION BEACON
- Ⓧ ← EMERGENCY PRE-EMPTION DETECTOR
- ▭ CURB RAMP
- Ⓧ CONTROLLER CABINET
- DC DEPRESSED CURB
- 4"/DY 4" WIDTH / DOUBLE YELLOW LINE
- 6"/W 6" WIDTH / SOLID WHITE LINE
- 24"/W 24" WIDTH / SOLID WHITE LINE
- ∅4 PHASE NUMBER
- UTILITY POLE
- ☀ LUMINAIRE
- × × FENCE
- — — — — GUIDE RAIL



COUNTY: LANCASTER COUNTY  
 MUNICIPALITY: MOUNT JOY TOWNSHIP  
 INTERSECTION: CLOVERLEAF ROAD (SR 4025) AND SCHWANGER ROAD (T-843)

REVIEWED: Robert N. [Signature] 5/15/08  
 MUNICIPAL OFFICIAL DATE

APPROVED: [Signature] 05/21/08  
 DIST TRAFFIC ENGR DATE

MOVEMENT, SEQUENCE, AND TIMING DIAGRAM

PERMIT NUMBER: 87-258 SHEET 2 OF 2  
 DATE ISSUED: 04-30-07 DATE REVISED: 7-1-11

# T-271

**GENERAL NOTES**

INSTALLATION, OPERATION, AND MAINTENANCE OF THIS TRAFFIC SIGNAL TO BE IN ACCORDANCE WITH PENNSYLVANIA DEPARTMENT OF TRANSPORTATION REGULATIONS ON OFFICIAL TRAFFIC CONTROL DEVICES.

NO MODIFICATIONS OF THIS INSTALLATION ARE PERMITTED UNLESS PRIOR APPROVAL IS GRANTED, IN WRITING, BY THE DEPARTMENT.

ALL MAINTENANCE NECESSARY FOR PROPER VISIBILITY OF THE SIGNALS, INCLUDING TRIMMING TREES, IS THE RESPONSIBILITY OF THE PERMITEE.

ALL SIGNS AND PAVEMENT MARKINGS INDICATED ON THIS DRAWING ARE CONSIDERED PART OF THE PERMIT AND ARE TO BE INSTALLED AND MAINTAINED BY THE PERMITEE, UNLESS OTHERWISE INDICATED. EXCEPT THE LONGITUDINAL PAVEMENT MARKINGS ON STATE HIGHWAYS WHICH WILL BE MAINTAINED BY THE DEPARTMENT.

INSTALL POST MOUNTED SIGNALS WITH THE SIGNAL HEADS A MINIMUM OF 2 FEET BEHIND THE FACE OF THE CURB OR EDGE OF THE SHOULDER. SUPPORT POLES FOR OVERHEAD SIGNALS WILL HAVE A MINIMUM HORIZONTAL CLEARANCE OF 2 FEET.

THE BOTTOM OF SIGNAL HEADS AND SIGNS ERECTED OVER THE ROADWAY ARE NOT TO BE LESS THAN 15 FEET NOR MORE THAN 19 FEET ABOVE THE ROADWAY. THE BOTTOM OF POST MOUNTED SIGNAL HEADS ARE NOT TO BE LESS THAN 8 FEET NOR MORE THAN 15 FEET ABOVE THE SIDEWALK OR PAVEMENT GRADE.

THE MINIMUM HORIZONTAL DISTANCE BETWEEN SIGNAL HEADS MEASURED AT RIGHT ANGLES TO THE APPROACH IS TO BE 8 FEET.

PERMITEE SHALL OBTAIN A HIGHWAY OCCUPANCY PERMIT FOR EMBANKMENT REMOVAL, CURBING AND/OR SIDEWALK, DRAINAGE STRUCTURES, CHANGES IN HIGHWAY GEOMETRY, PAVEMENT WIDENING, OR INSTALLATION OF ADDITIONAL LANES.

CONDUIT INSTALLED IN BITUMINOUS ROADWAY LESS THAN 5 YEARS OLD, OR CONCRETE ROADWAY REGARDLESS OF AGE, MUST BE BORED OR JACKED UNDER THE ROADWAY. INSTALL IN ACCORDANCE WITH TRAFFIC SIGNAL STANDARDS TC-7800 SERIES.

THIS DRAWING CANNOT BE USED AS A CONSTRUCTION DRAWING UNLESS THE PERMITEE COMPLIES WITH THE PROVISIONS OF ACT 199, PREVENTION OF DAMAGE TO UNDERGROUND UTILITIES, EFFECTIVE NOVEMBER 30, 2004 PRIOR TO CONSTRUCTION CONSULT WITH UTILITY COMPANIES TO RESOLVE ANY PROBLEMS WHICH MAY BE CREATED DUE TO THE LOCATION OF UTILITIES.

PAVEMENT MARKINGS WILL BE PLACED IN ACCORDANCE WITH THE DEPARTMENT OF TRANSPORTATION PAVEMENT MARKING HANDBOOK.

PERMITEE IS RESPONSIBLE FOR OBTAINING APPROVAL FOR INSTALLATION OF TRAFFIC SIGNAL DEVICES LOCATED OUTSIDE HIGHWAY RIGHT-OF-WAY.

TRAFFIC SIGNALS INSTALLED USING LIQUID FUELS TAX FUNDS MUST CONFORM TO DEPARTMENT SPECIFICATIONS AS SET FORTH IN CURRENT PUBLICATION 408, SUPPLEMENTS AND STANDARD DRAWINGS.

PHASE	2+5	2+6	8	RAMP PRE-EMP	PRE-EMP A	PRE-EMP B	PRE-EMP C	EMERGENCY FLASHING
SIGNAL INTERVAL	1 2 3	1 2 3	1 2 3	1 2 3	1 2 3	1 2 3	1 2 3	
1,2	G Y R	G Y R	R R R	R R R	R R R	R R R	R R R	Y
3,9	G Y R	G Y R	R R R	R R R	R R R	R R R	R R R	Y
4,5	R R R	G Y R	R R R	R R R	G Y R	R R R	R R R	Y
6,7,8	R R R	R R R	R G Y	R R R	R R R	R R R	G Y R	P
FAIL-SAFE LAMP A				OFF OFF OFF	ON OFF OFF	OFF OFF OFF	OFF OFF OFF	
FAIL-SAFE LAMP B				OFF OFF OFF	OFF OFF OFF	ON OFF OFF	OFF OFF OFF	
FAIL-SAFE LAMP C				OFF OFF OFF	OFF OFF OFF	OFF OFF OFF	ON OFF OFF	

FIXED	4	2	4	2	3	2.5	20	3	2.5	▲	4	2	▲	4	2	▲	3	2.5
MINIMUM	7		12		3													
SEC / ACT			3															
MAXIMUM INITIAL			25															
PASSAGE	3		6		3													
TBR			13															
TTR			12															
MINIMUM GAP			3															
MAXIMUM 1	16		50		19													
MAXIMUM 2	16		38		44													
REFER TO SYSTEM PERMIT	I-0003 FOR PA 283			INCIDENT TIMINGS														
PEDESTRIAN																		
MEMORY	NL	MIN	NL		NL													

▲ FOR DURATION OF PRE-EMPTION  
 MAXIMUM 2 TO OPERATE FROM 2:00 PM TO 7:00 PM, MONDAY THRU FRIDAY  
 MAXIMUM 1 TO OPERATE ALL OTHER TIMES

**OPERATION NOTES**

- 1) G IF FOLLOWED BY 2+6
- 2) G IF FOLLOWED BY 2+6
- 3) SIGNAL TO INDICATE G WHEN RETURNING TO NORMAL OPERATION

**DETECTOR NOTES**

- DETECTOR 2 CALLS AND EXTENDS PHASE 2 - PRESENCE
- DETECTOR 5a CALLS AND EXTENDS PHASE 5 - PRESENCE
- DETECTOR 6 CALLS AND EXTENDS PHASE 6 - PRESENCE
- DETECTION ZONE 8a CALLS AND EXTENDS PHASE 8 - PRESENCE

**EMERGENCY PRE-EMPTION NOTES:**

CONTROLLER TO BE EQUIPPED WITH EMERGENCY PRE-EMPTION EQUIPMENT FOR BOTH THE NORTHBOUND AND SOUTHBOUND APPROACHES OF CLOVERLEAF ROAD (SR 4025) AND THE WESTBOUND OFF-RAMP OF PA 0283 WHICH SHALL PROVIDE A SELECTIVE YELLOW INTERVAL, A GREEN INDICATION WILL BE GIVEN TO THE PRE-EMPTED APPROACH AND A RED INDICATION ON ALL OTHER APPROACHES.

EMERGENCY PREEMPTION MAY OCCUR DURING ANY INTERVAL OF THE NORMAL CONTROLLER OPERATIONS. DEPENDING ON THE DIRECTION OF TRAVEL OF THE EMERGENCY VEHICLE, ONE OF THE FOLLOWING PHASES SHALL BE CALLED: EMERGENCY PREEMPTION PHASE A, PHASE B, OR PHASE C. THE SYSTEM SHALL PROVIDE SERVICE ON A FIRST-COME, FIRST-SERVE BASIS. ONCE THE FIRST PRIORITY VEHICLE CALLS THE SYSTEM, IT SHALL PREVENT OTHER PREEMPTIVE VEHICLES FROM ENTERING CALLS UNTIL THE FIRST EMERGENCY VEHICLE RELEASES CONTROL AND CLEARS THE INTERSECTION.

- 1.) IF THE CONTROLLER OPERATION IS IN THE GREEN INTERVAL OF A NON-PREEMPTIVE VEHICLE PHASE, UPON ACTIVATION BY AN EMERGENCY VEHICLE, THE CONTROLLER SHALL TERMINATE THE INTERVAL IMMEDIATELY AND PROCEED NORMALLY THROUGH THE YELLOW AND ALL RED INTERVALS BEFORE PROCEEDING TO THE PREEMPTIVE PHASE.
- 2.) IF THE CONTROLLER OPERATION IS IN THE GREEN INTERVAL OF A PREEMPTIVE PHASE, UPON ACTIVATION BY AN EMERGENCY VEHICLE, THE CONTROLLER SHALL REMAIN IN THAT INTERVAL.
- 3.) IF THE CONTROLLER OPERATION IS IN THE YELLOW, YELLOW ARROW, OR ALL RED INTERVAL OF ANY VEHICLE PHASE, UPON ACTIVATION BY AN EMERGENCY VEHICLE, THE CONTROLLER SHALL TIME OUT OF THOSE INTERVALS NORMALLY AND PROCEED TO THE PREEMPTION PHASE.
- 4.) THE GREEN INTERVAL SHALL EXTEND FOR THE LENGTH OF THE PREEMPTION ACTUATION BUT SHALL BE A MAXIMUM OF 30 SECONDS FOR EACH EMERGENCY PREEMPTION PHASE. UPON TERMINATION OF THE PREEMPTION PHASE, THE CONTROLLER SHALL PROCEED NORMALLY THROUGH THE YELLOW, YELLOW ARROW, AND ALL RED INTERVALS TO THE PRE-DESIGNATED POST PREEMPTION PHASE, THEN TO NORMAL "PHASE NEXT" OPERATION.

**RAMP PREEMPTION NOTES:**

- WHEN PREEMPTION IS ACTIVATED, ALL YELLOW AND RED INDICATIONS, SHALL TIME OUT, FOLLOWED BY THE GREEN INTERVAL OF THE PRE-EMPTION PHASE.
- IF THE SIGNALS ARE FLASHING WHEN ACTIVATED FOR PRE-EMPTION, ALL SIGNALS SHALL REMAIN FLASHING.
- UPON COMPLETION OF THE PRE-EMPTION PHASE, IN RETURNING TO NORMAL OPERATION, PHASE 2+6 SHALL FOLLOW.
- A CONSTANT CALL ON THE RAMP PRE-EMPTION DETECTOR 8 FOR 10 SECONDS SHALL START THE PRE-EMPT CALL.
- A CONSTANT CALL ON THE RAMP PRE-EMPTION DETECTOR 8 FOR 180 SECONDS SHALL INHIBIT THE PRE-EMPT CALL.

PLAN SYMBOL	SERIES	SIZE	MESSAGE
D3-4	84"x16"	STREET SIGN "Clover leaf Rd"	
R5-1	36"x36"	DO NOT ENTER	
R10-12	30"x36"	LEFT TURN YIELD ON GREEN ●	
R3-3	36"x36"	NO TURNS SIGN	
W12-1	36"x36"	DOUBLE ARROW SIGN	
R9-3	18"x18"	NO PEDESTRIAN CROSSING	
R3-1	36"x36"	NO RIGHT TURN SIGN	
R3-8A (L-S)	30"x30"	LANE USE CONTROL SIGN	
R6-1L	36"x12"	HORIZONTAL LEFT ONE WAY SIGN	
R6-1R	36"x12"	HORIZONTAL RIGHT ONE WAY SIGN	
R1-2	48"x48"	YIELD SIGN	
R3-8A (LS-R)	30"x30"	LANE USE CONTROL SIGN	
R8-3	24"x24"	NO PARKING SYMBOL SIGN	
W3-3	36"x36"	SIGNAL AHEAD	

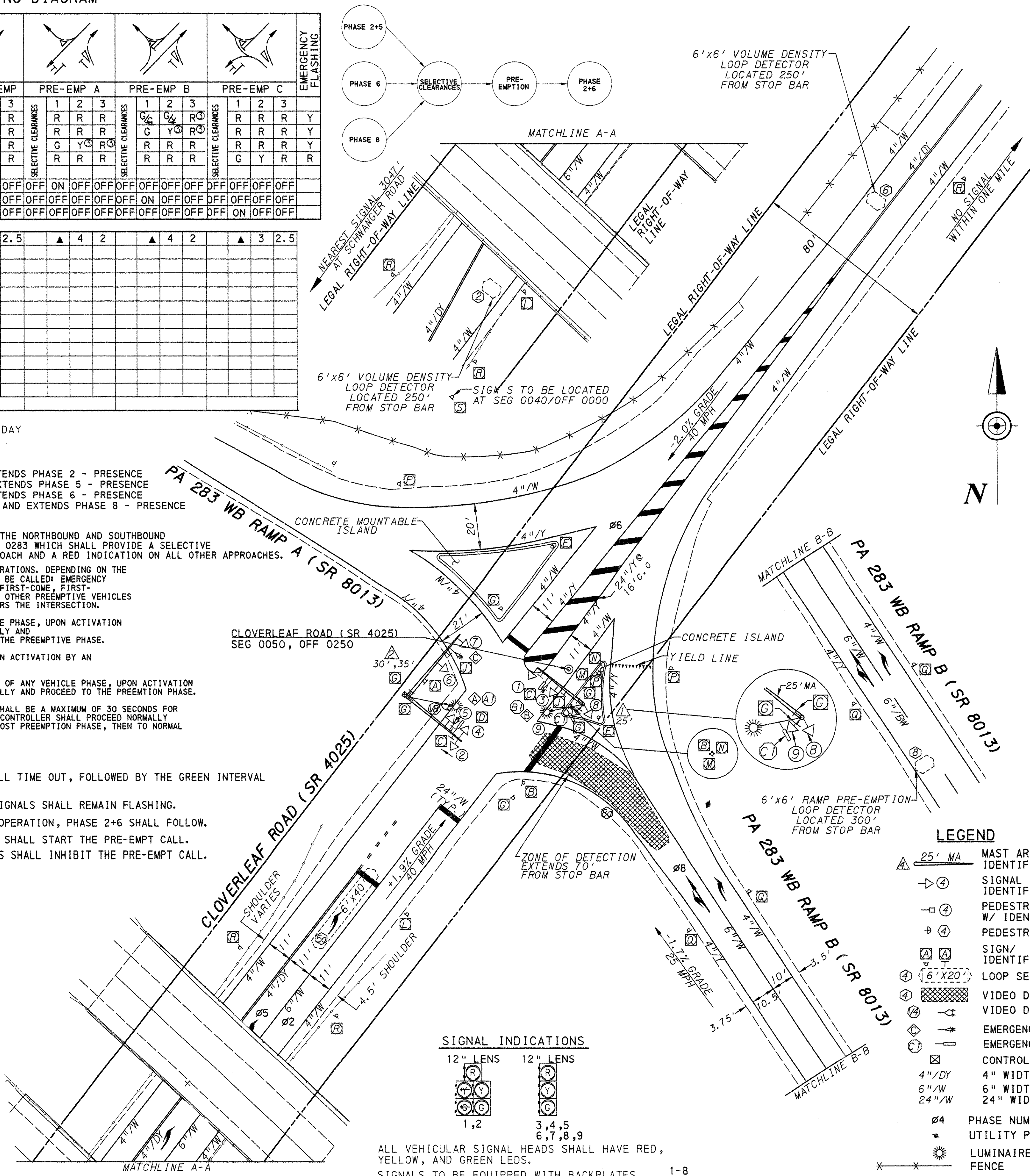

**SIGNAL INDICATIONS**

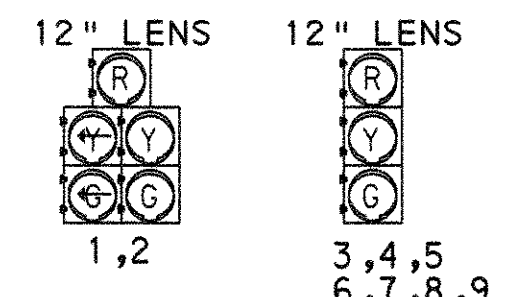

ALL VEHICULAR SIGNAL HEADS SHALL HAVE RED, YELLOW, AND GREEN LEDS.  
 SIGNALS TO BE EQUIPPED WITH BACKPLATES 1-8

**LEGEND**

- 25' MA MAST ARM/ IDENTIFYING LENGTH
- Signal head symbols IDENTIFYING NUMBER
- W/ Pedestrian signal head IDENTIFYING NUMBER
- ⊕ Pedestrian pushbutton
- ⊕ Sign/ IDENTIFYING LETTER
- ⊕ Loop sensor/size
- Video detection area symbols VIDEO DETECTOR
- ⊕ Emergency pre-emption beacon
- ⊕ Emergency pre-emption detector
- ⊕ Controller cabinet
- ⊕ 4" width / double yellow line
- ⊕ 6" width / solid white line
- ⊕ 24" width / solid white line
- ⊕ Phase number
- ⊕ Utility pole
- ⊕ Luminaire
- ⊕ Fence
- ⊕ Guide rail

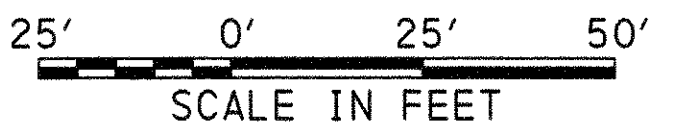

COUNTY: LANCASTER COUNTY  
 MUNICIPALITY: MOUNT JOY TOWNSHIP  
 INTERSECTION: CLOVERLEAF ROAD (SR 4025) AND PA 283 WB RAMP B (SR 8013)  
 REVIEWED: *Steph A. Cas* 06/23/2011  
 MUNICIPAL OFFICIAL DATE  
 RECOMMENDED: *Joan C. Bentley* 07/01/2011  
 DIST TRAFFIC ENGR DATE

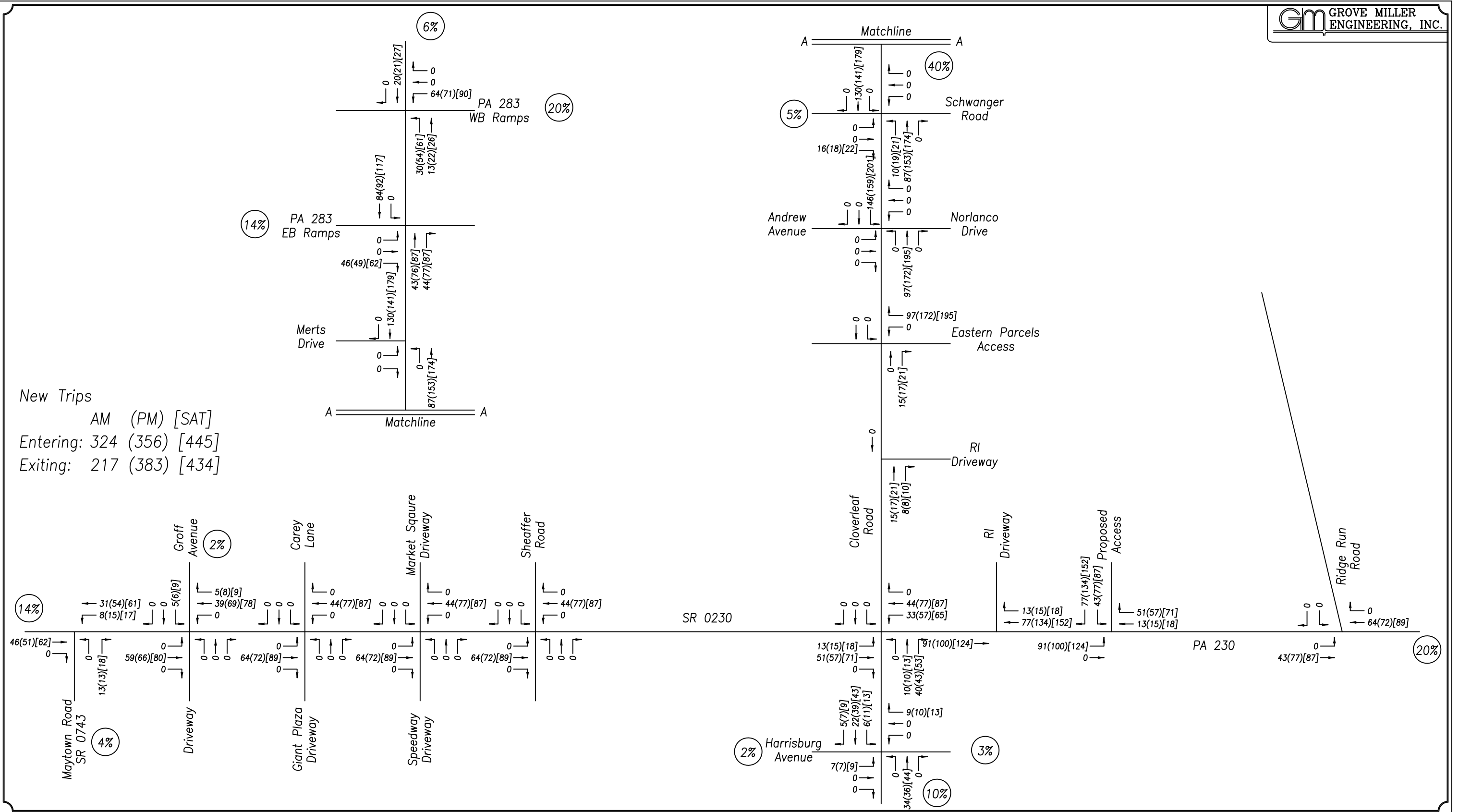
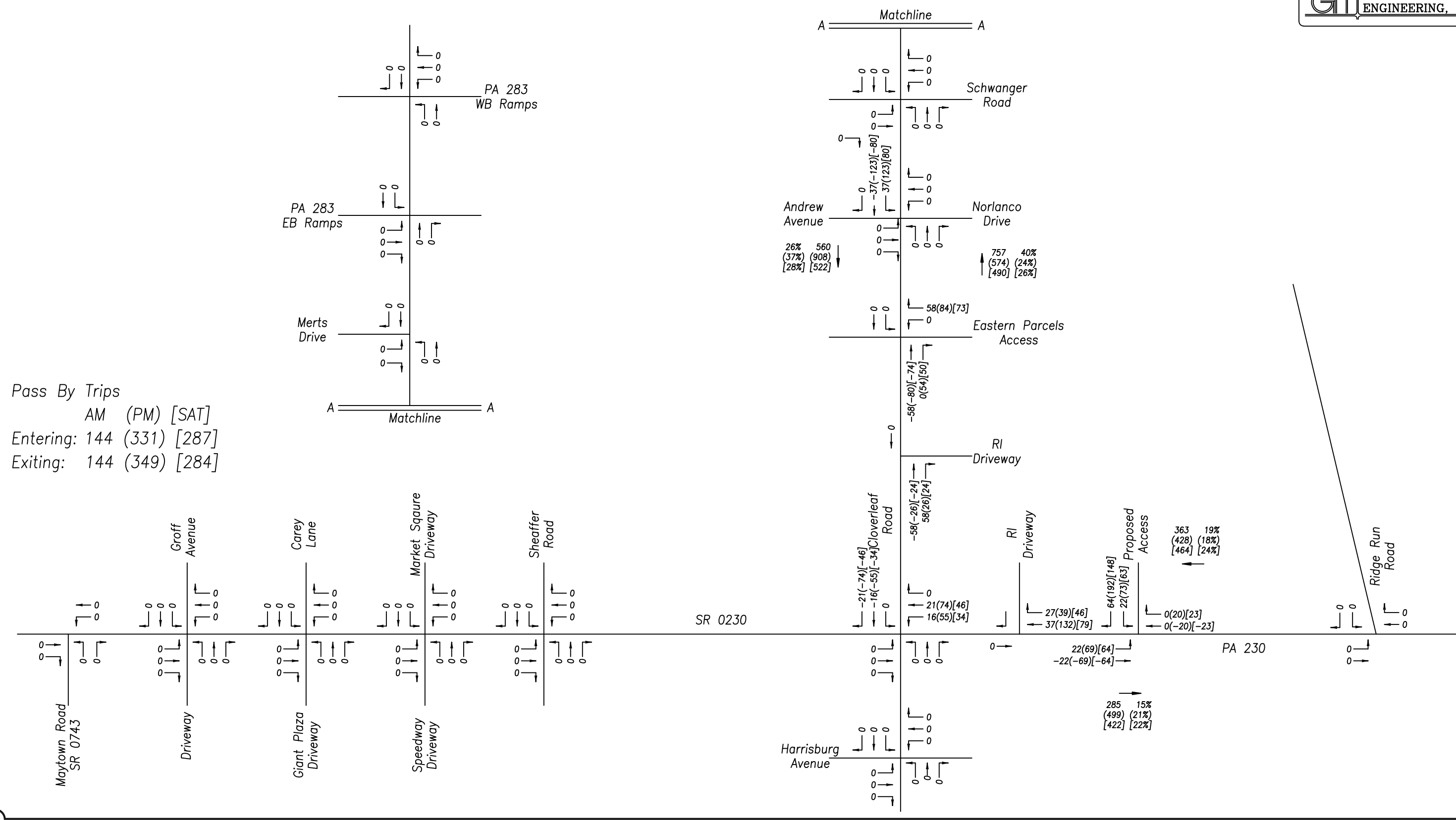

FIGURE 4a. NEW TRIP DISTRIBUTION



Transportation Impact Study  
 PENNMARK  
 PROPERTY  
 Mount Joy Township, Lancaster Co.

FIGURE 4b. PASS-BY TRIP DISTRIBUTION

# **APPENDIX C**

## **OPENING YEAR CONDITIONS**



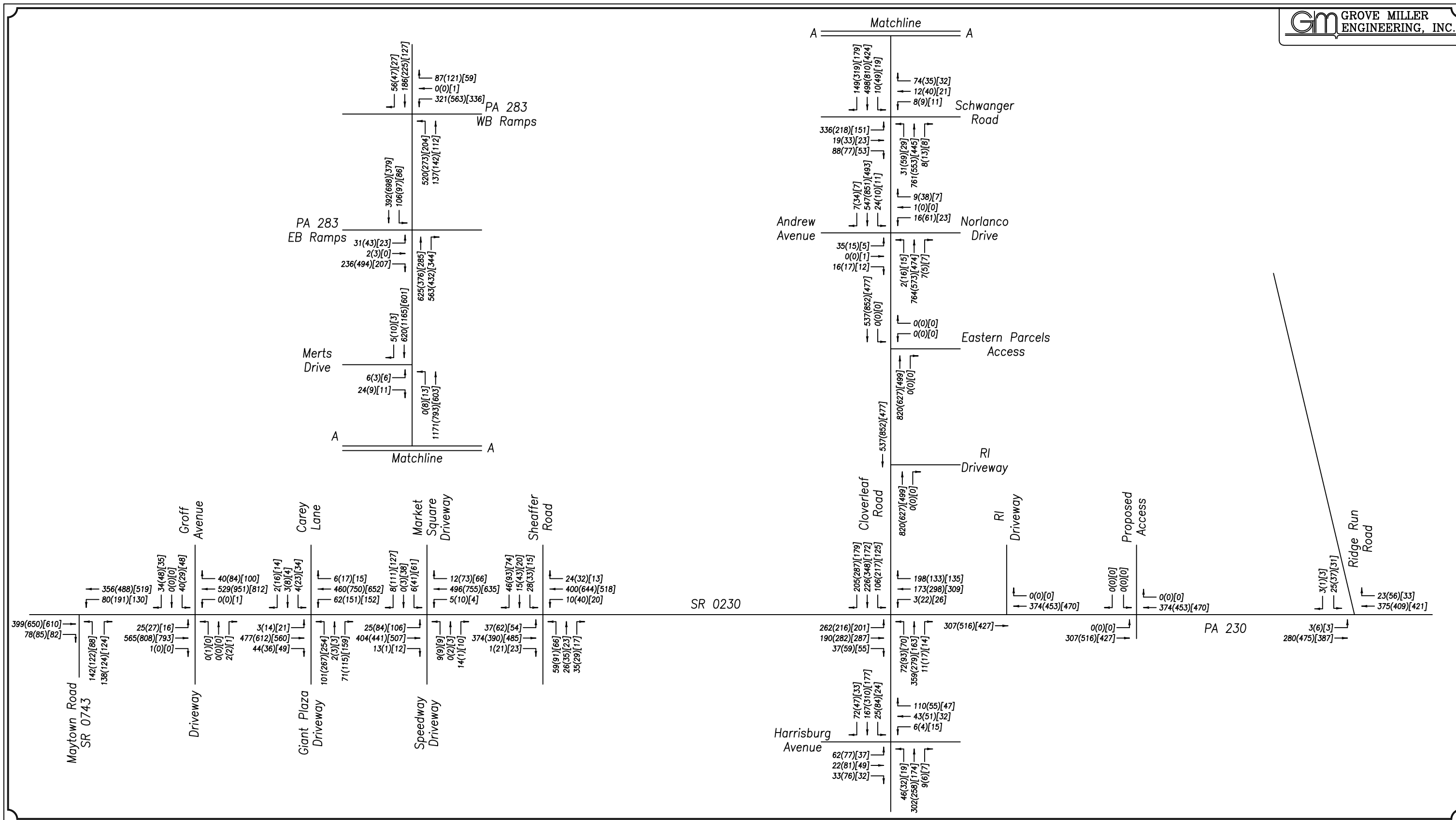
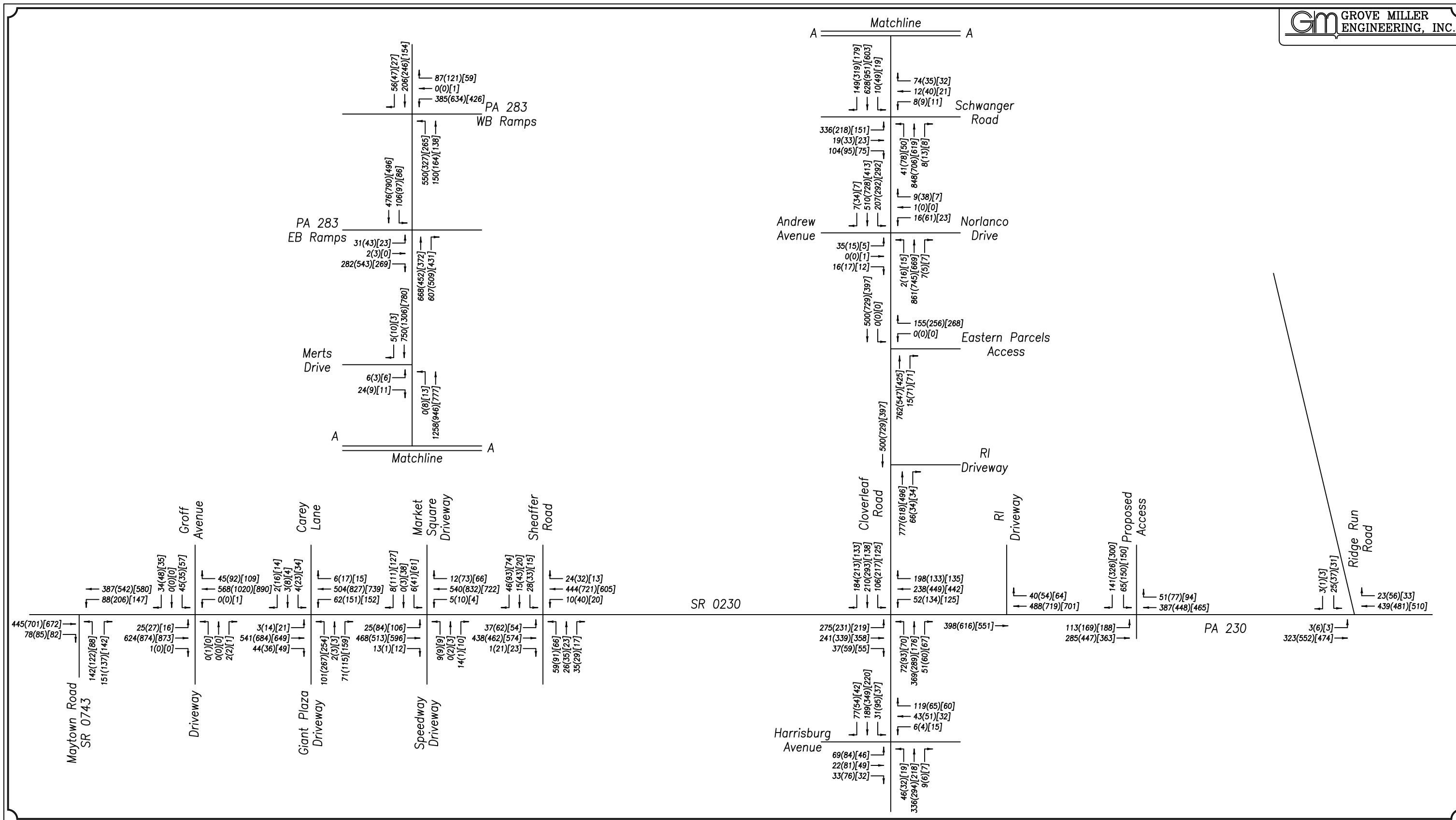

FIGURE 5a. 2024 OPENING YEAR TRAFFIC VOLUMES, NO BUILD



Transportation Impact Study  
 PENNMAR  
 PROPERTY  
 Mount Joy Township, Lancaster Co.

FIGURE 5b. 2024 OPENING YEAR TRAFFIC VOLUMES, BUILD

# **APPENDIX D**

## **HORIZON YEAR CONDITIONS**

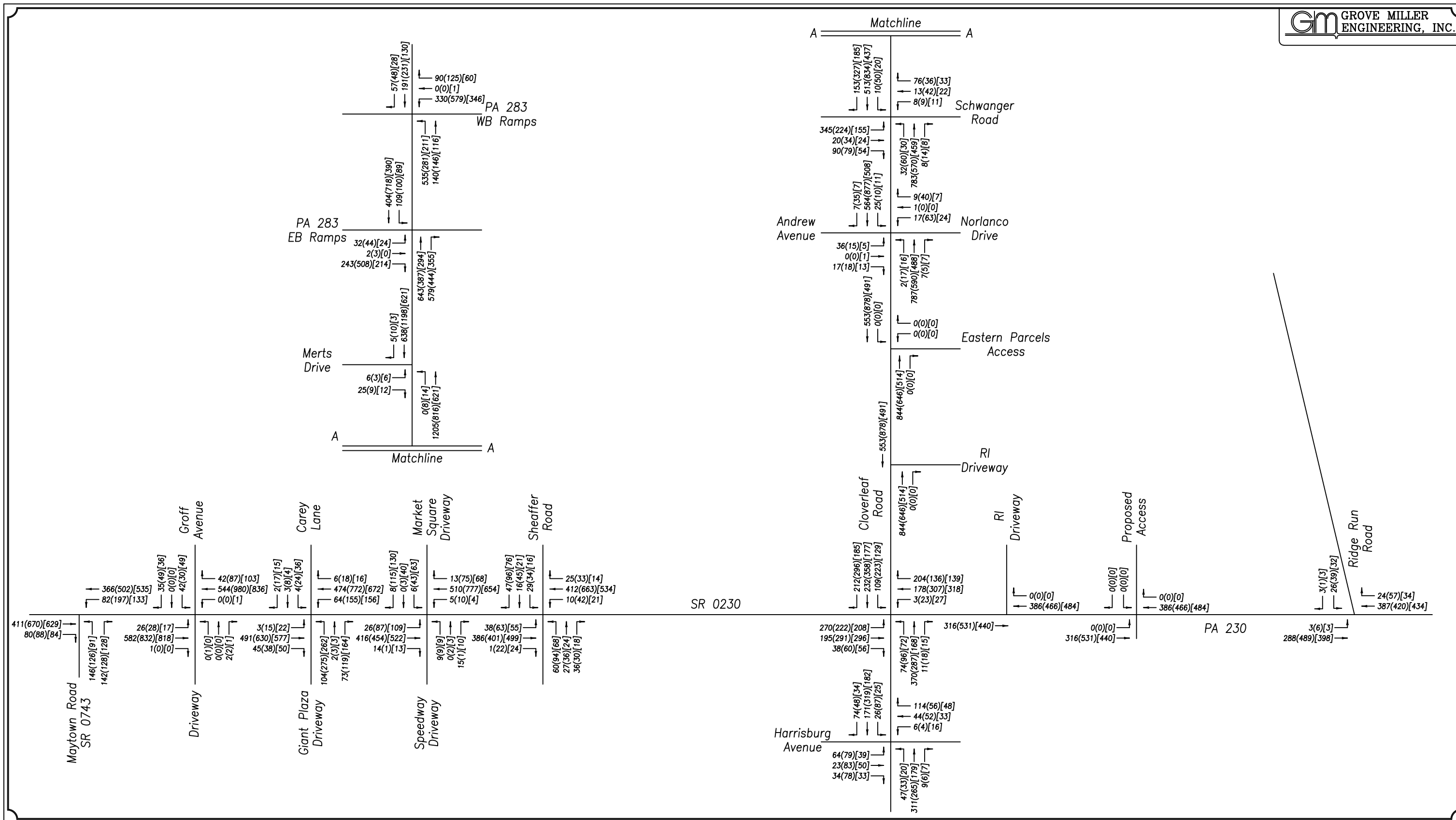

FIGURE 6a. 2029 HORIZON YEAR TRAFFIC VOLUMES, NO BUILD

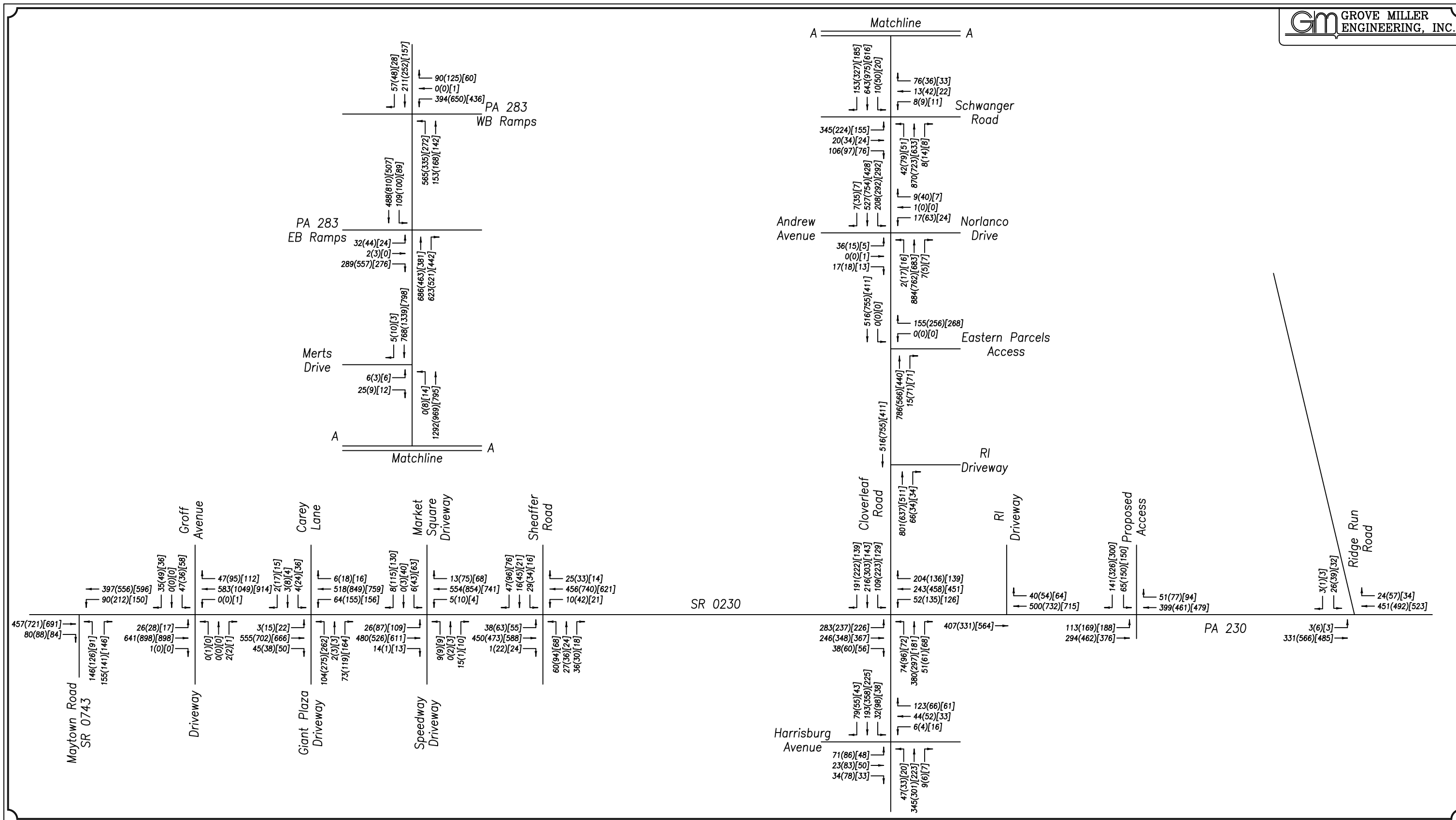

FIGURE 6b. 2029 HORIZON YEAR TRAFFIC VOLUMES, BUILD

# **APPENDIX E**

## **EXISTING TRANSPORTATION CONDITIONS**



PROJECT: 804.02  
 INTERSECTION: SR 0230 &  
 Groff Avenue  
 DATE: 3/2022  
 DRAWN BY: GEC

EASTBOUND

STREET: SR 0230  
 GRADE: -3.0  
 MPH: 40

WESTBOUND

STREET: SR 0230  
 GRADE: +6.0  
 MPH: 40

NORTHBOUND

STREET: DRIVEWAY  
 GRADE: -2.0  
 MPH: NOT POSTED

SOUTHBOUND

STREET: Groff Avenue  
 GRADE: -3.0  
 MPH: 35

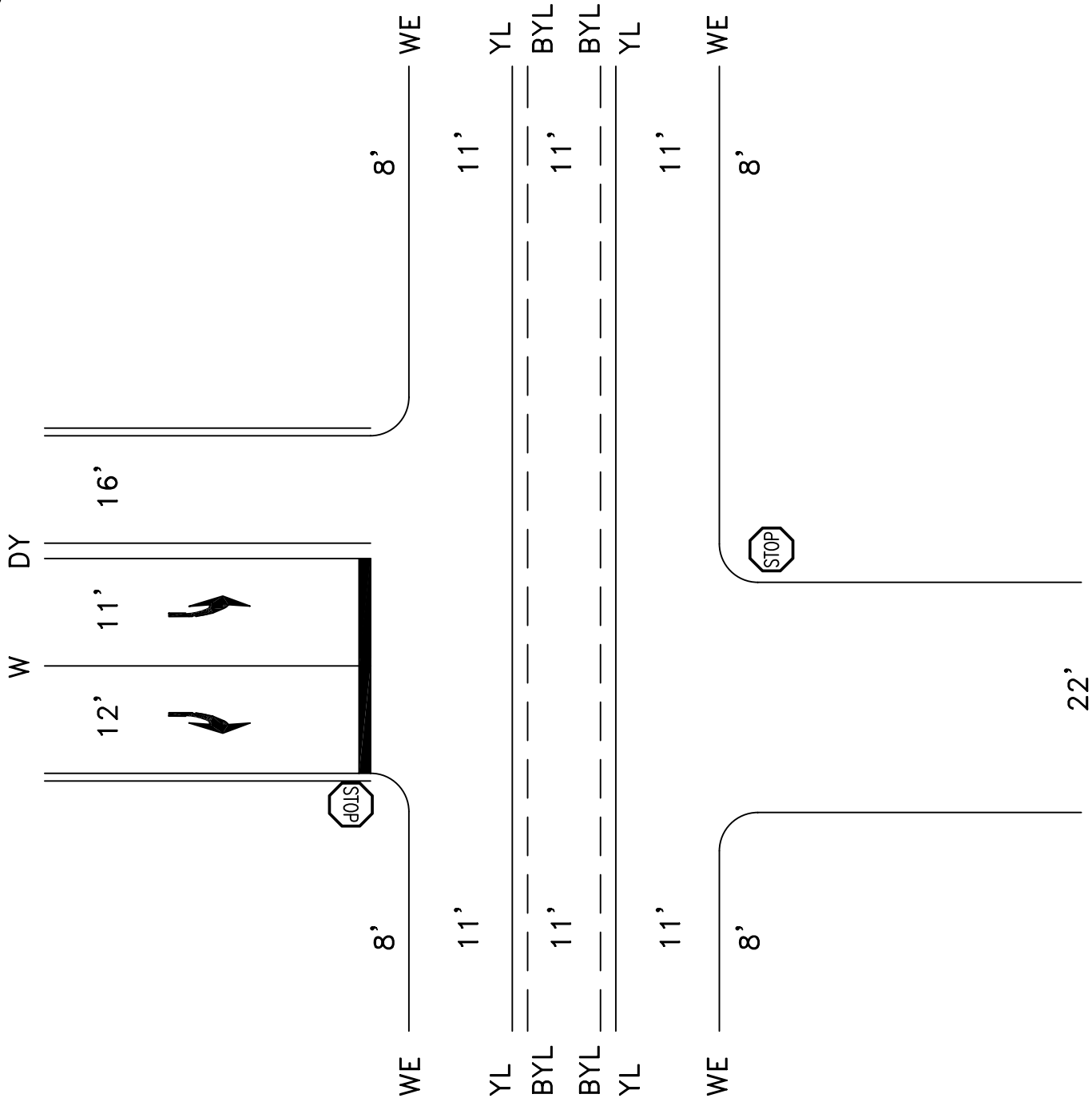



GROVE MILLER  
ENGINEERING, INC.

PROJECT: 804.02  
INTERSECTION: Colebrook Rd  
& Harrisburg Avenue  
DATE: 3/2022  
DRAWN BY: GEC

EASTBOUND

STREET: Harrisburg Avenue  
GRADE: -1%  
MPH: 35

WESTBOUND

STREET: Harrisburg Avenue  
GRADE: -1%  
MPH: 35

NORTHBOUND

STREET: Colebrook Road  
GRADE: +1%  
MPH: 25

SOUTHBOUND

STREET: Colebrook Road  
GRADE: -5%  
MPH: 25

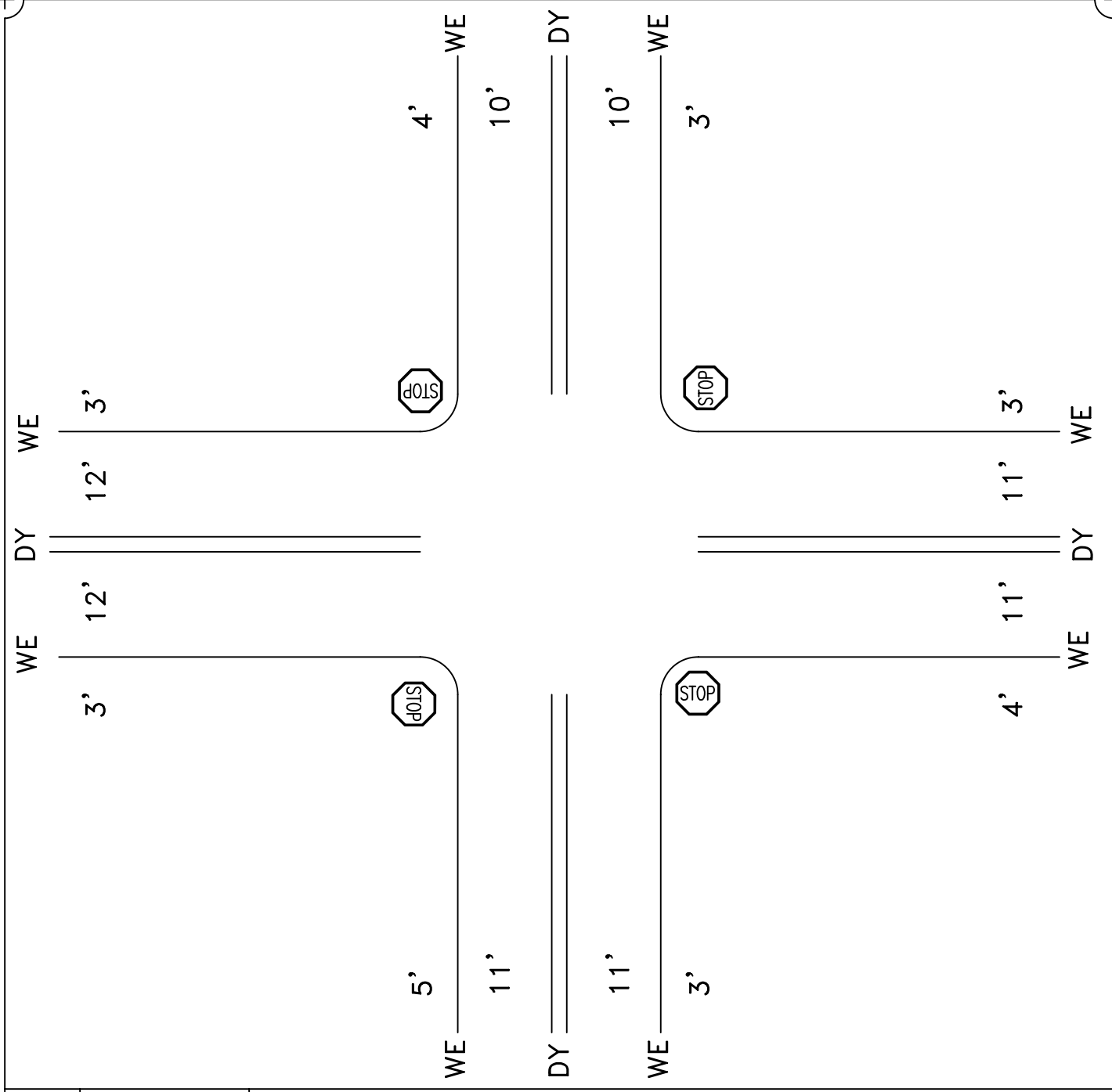





PROJECT: 804.02  
 INTERSECTION: SR 0230 &  
 Ridge Run Road  
 DATE: 3/2022  
 DRAWN BY: GEC

EASTBOUND

STREET: SR 0230  
 GRADE: -1.0  
 MPH: 55

WESTBOUND

STREET: SR 0230  
 GRADE: +1.0  
 MPH: 55

NORTHBOUND

STREET: N/A  
 GRADE: N/A  
 MPH: N/A

SOUTHBOUND

STREET: Ridge Run Rd  
 GRADE: +2.0  
 MPH: 35

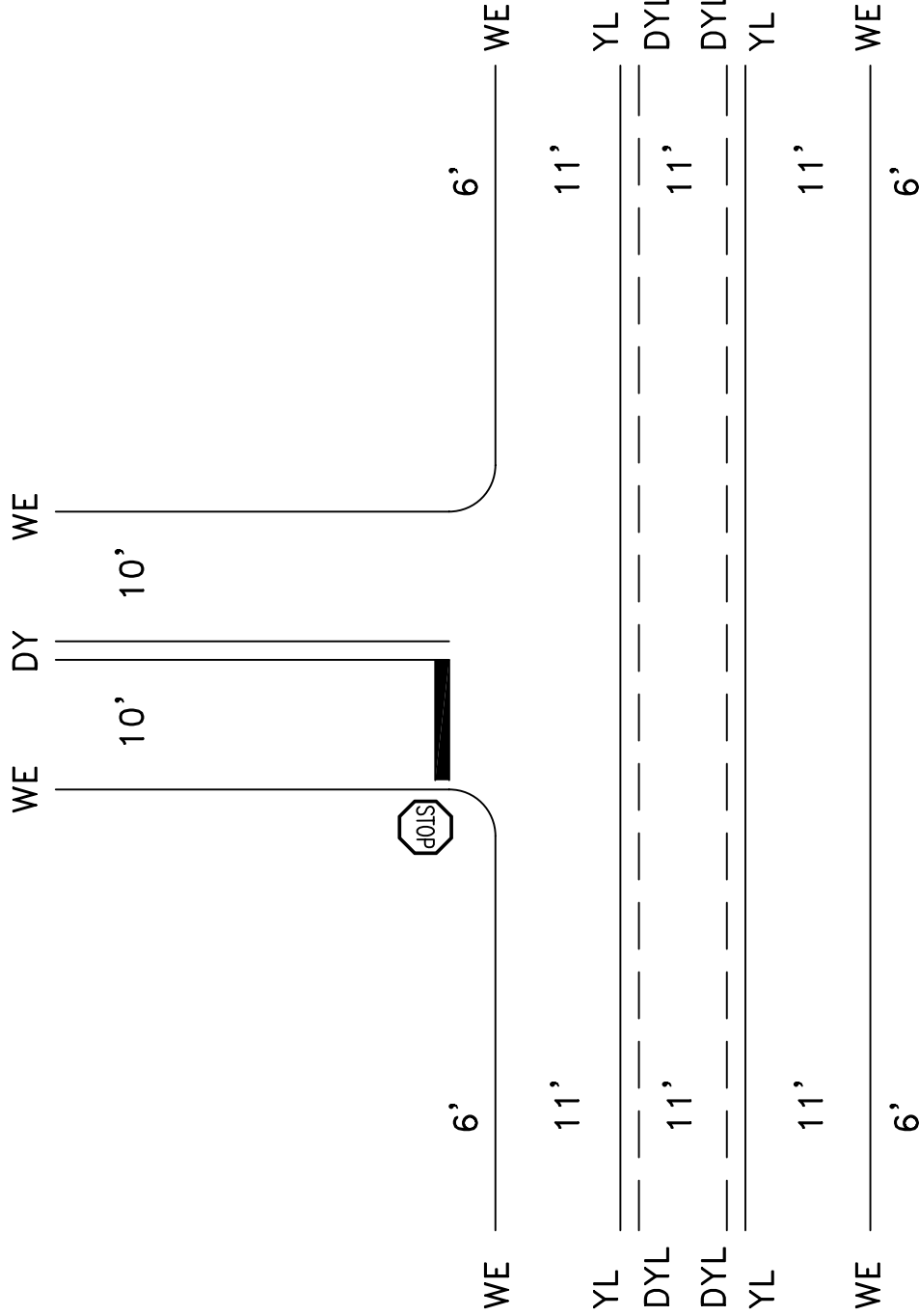



GROVE MILLER  
ENGINEERING, INC.

PROJECT: 804.02  
INTERSECTION: Cloverleaf Rd  
& Merts Drive  
DATE: 3/2022  
DRAWN BY: GEC

EASTBOUND

STREET: Merts Drive  
GRADE: 0%  
MPH: 25

NORTHBOUND

STREET: Cloverleaf Road  
GRADE: -2%  
MPH: 40

SOUTHBOUND

STREET: Cloverleaf Road  
GRADE: +2  
MPH: 40

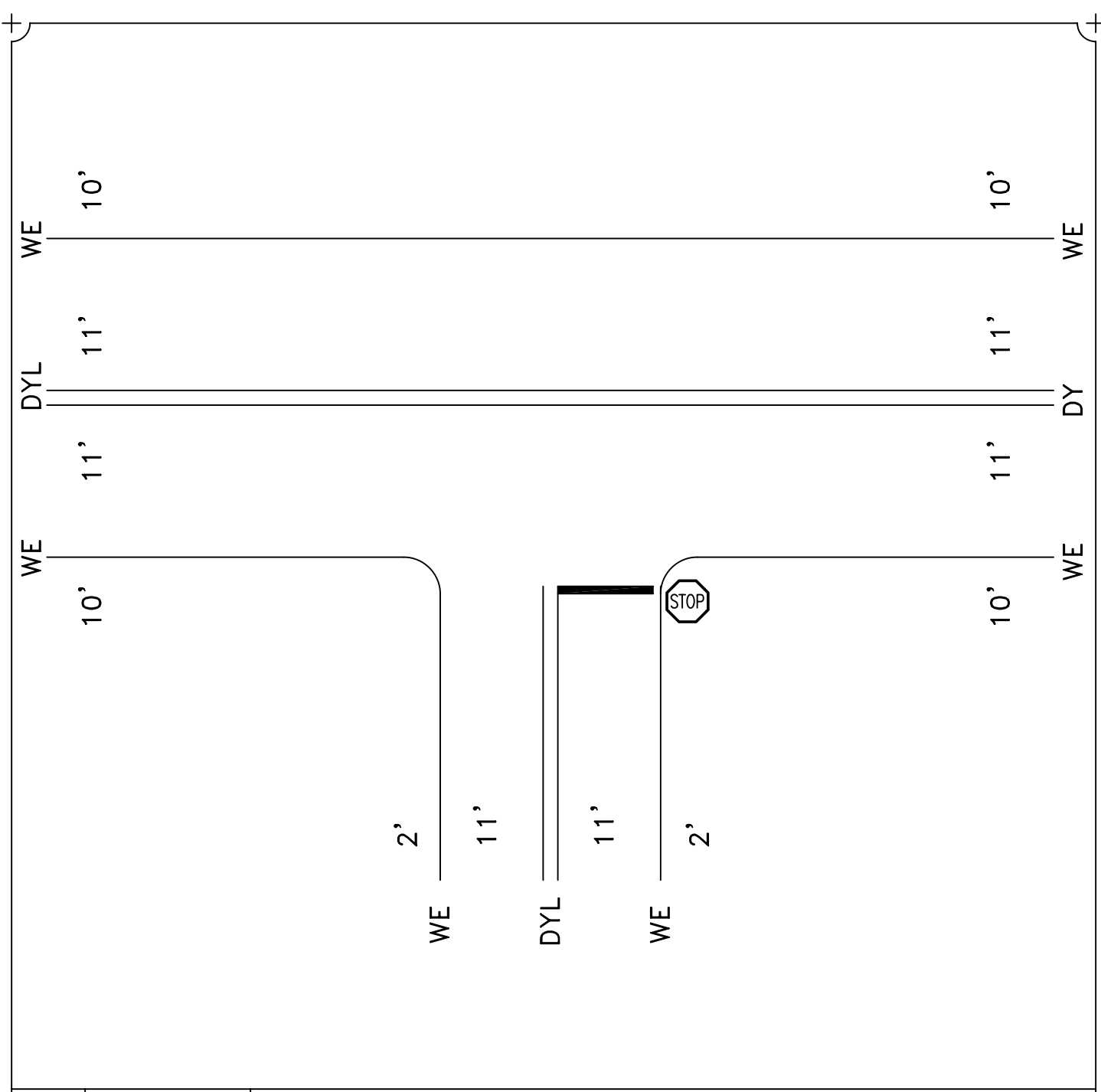



GROVE MILLER  
ENGINEERING, INC.

PROJECT: 804.02  
INTERSECTION: Cloverleaf Rd  
& PA 283 EB Ramps  
DATE: 3/2022  
DRAWN BY: GEC

EASTBOUND

STREET: PA 283 EB Off-Ramp  
GRADE: -3.0  
MPH: Not Posted

WESTBOUND

STREET: PA 283 EB On-Ramp  
GRADE: +3.0  
MPH: Not Posted

NORTHBOUND

STREET: Cloverleaf Rd  
GRADE: -2  
MPH: 40

SOUTHBOUND

STREET: Cloverleaf Road  
GRADE: -2  
MPH: 40

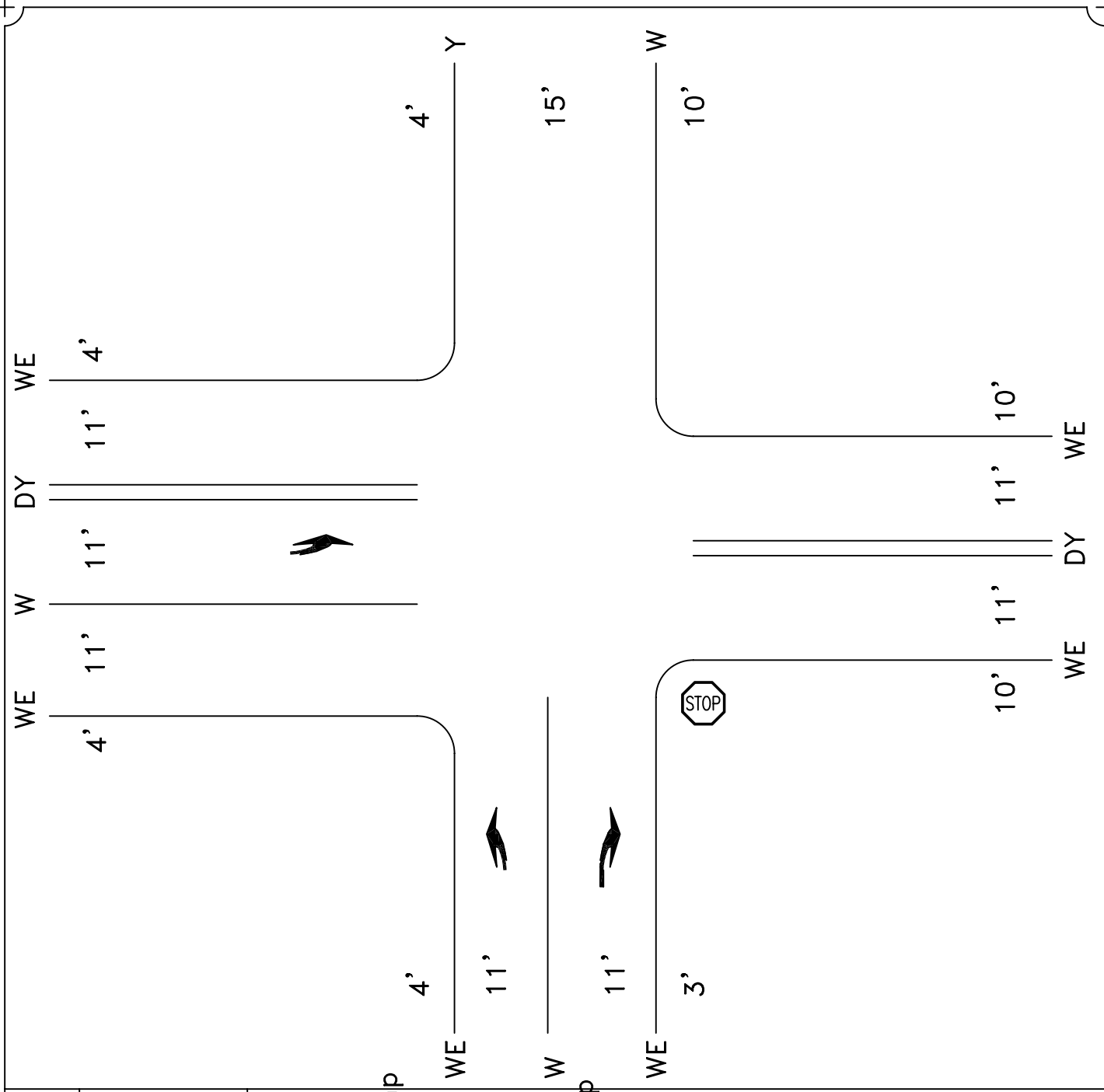

**RURAL**

**to**

**Rural Places**

**Suburban  
Neighborhood**

**Suburban  
Corridor**

**Suburban  
Center**



*Figure 5.1 Roads in Context*



**URBAN**

Town/Village  
Neighborhood

Town Center

Urban Core

**REGIONAL**

Regional  
Arterial

Community  
Arterial

Community  
Collector

Neighborhood  
Collector

to

**LOCAL**

Local Road/  
Street

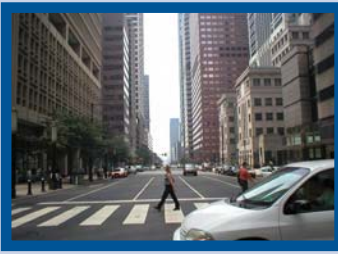



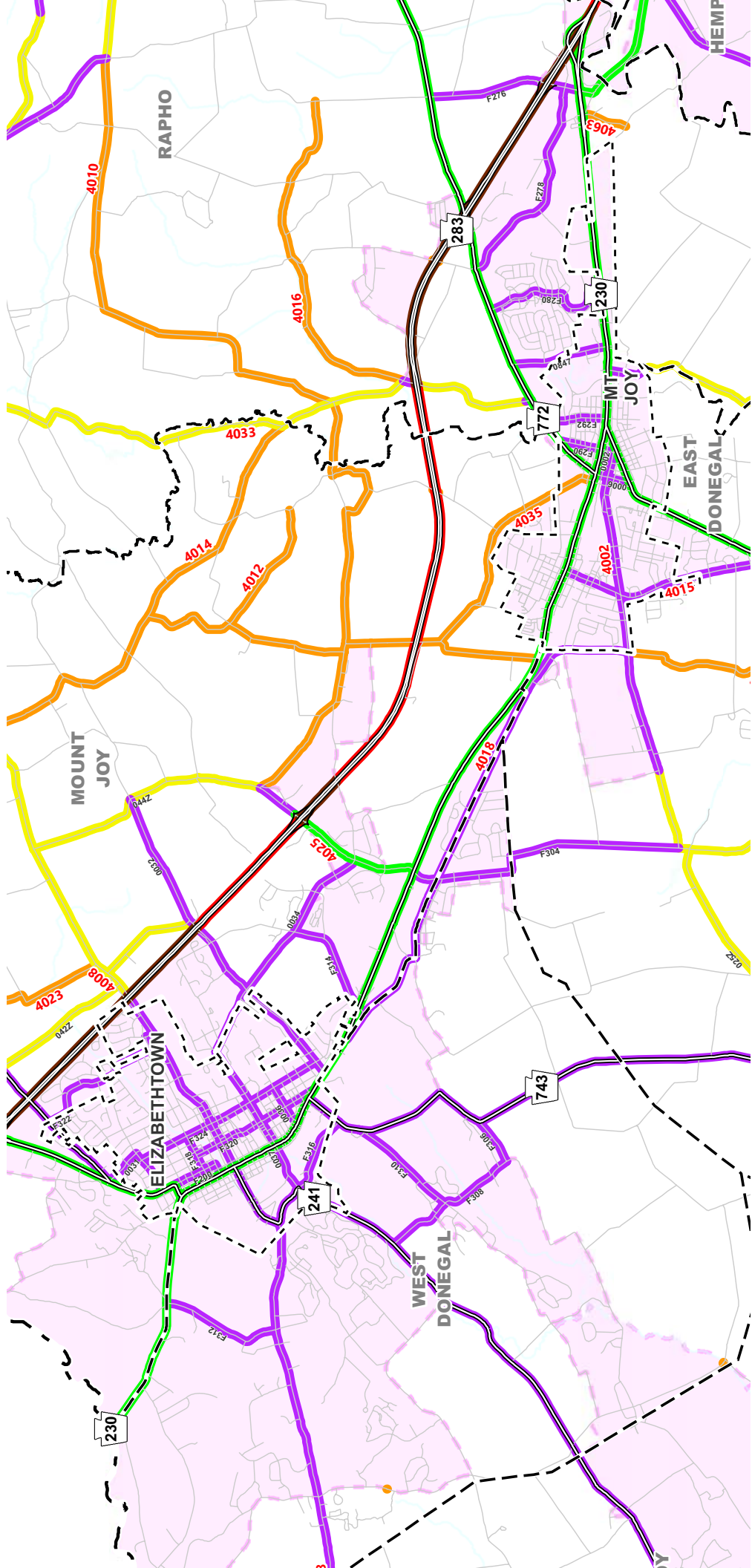









The photos enclosed in a yellow box indicate the Town Center and Core City streets that also operate as a local or regional Main Street.





# Legend

-  STATE
-  COUNTY
-  CITY or BORO
-  TOWNSHIP
-  INTERSTATE HIGHWAYS
-  OTHER FREEWAYS AND EXPRESSWAYS
-  OTHER PRINCIPAL ARTERIAL HIGHWAYS
-  MINOR ARTERIALS
-  MAJOR COLLECTOR
-  MINOR COLLECTOR
-  LOCAL ROADS
-  2010 SMALL URBAN BOUNDARY
-  2010 LARGE URBAN BOUNDARY

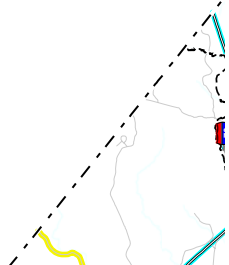

# **APPENDIX F**

## **STUDY AREA PHOTOGRAPHS**





SR 0230 looking east (200') at SR 0743



SR 0230 looking east (50') at SR 0743



SR 0230 looking west (200') at SR 0743



SR 0230 looking west (50') at SR 0743



SR 0743 looking north (200') at SR 0230



SR 0743 looking north (50') at SR 0230



SR 0230 looking east (200') at Groff Avenue



SR 0230 looking east (50') at Groff Avenue



SR 0230 looking west (200') at Groff Avenue



SR 0230 looking west (50') at Groff Avenue



Groff Avenue looking south (200') at SR 0230



Groff Avenue looking south (50') at SR 0230



SR 0230 looking east (200') at Carey Lane/Giant Plaza Driveway



SR 0230 looking east (50') at Carey Lane/Giant Plaza Driveway



SR 0230 looking west (200') at Carey Lane/Giant Plaza Driveway



SR 0230 looking west (50') at Carey Lane/Giant Plaza Driveway





Giant Plaza Driveway looking north (200') at SR 0230



Giant Plaza Driveway looking north (50') at SR 0230



Carey Lane looking south (200') at SR 0230



Carey Lane looking south (50') at SR 0230



SR 0230 looking east (200') at Hess Driveway/Market Square Driveway



SR 0230 looking east (50') at Hess Driveway/Market Square Driveway



SR 0230 looking west (200') at Hess Driveway/Market Square Driveway



SR 0230 looking west (50') at Hess Driveway/Market Square Driveway



Market Square Driveway looking south (200') at SR 0230



Market Square Driveway looking south (50') at SR 0230



Hess Driveway looking north at SR 0230



SR 0230 looking east (200') at Sheaffer Road



SR 0230 looking east (50') at Sheaffer Road



SR 0230 looking west (200') at Sheaffer Road



SR 0230 looking west (50') at Sheaffer Road





Sheaffer Road looking north (200') at SR 0230



Sheaffer Road looking north (50') at SR 0230



Sheaffer Road looking south (200') at SR 0230



Sheaffer Road looking south (50') at SR 0230



SR 0230 looking east (200') at Cloverleaf Road



SR 0230 looking east (50') at Cloverleaf Road



SR 0230 looking west (200') at Cloverleaf Road



SR 0230 looking west (50') at Cloverleaf Road



Colebrook Road looking north (200') at SR 0230



Colebrook Road looking north (50') at SR 0230



Cloverleaf Road looking south (200') at SR 0230



Cloverleaf Road looking south (50') at SR 0230



SR 0230 looking east (200') at Ridge Run Road



SR 0230 looking east (50') at Ridge Run Road



SR 0230 looking west (200') at Ridge Run Road



SR 0230 looking west (50') at Ridge Run Road





Ridge Run Road looking south (200') at SR 0230



Ridge Run Road looking south (50') at SR 0230



Harrisburg Avenue looking east (200') at Colebrook Road



Harrisburg Avenue looking east (50') at Colebrook Road



Harrisburg Avenue looking west (200') at Colebrook Road



Harrisburg Avenue looking west (50') at Colebrook Road



Colebrook Road looking north (200') at Harrisburg Avenue



Colebrook Road looking north (50') at Harrisburg Avenue



Colebrook Road looking south (200') at Harrisburg Avenue



Colebrook Road looking south (50') at Harrisburg Avenue



Andrew Avenue looking east (200') at Cloverleaf Road



Andrew Avenue looking east (50') at Cloverleaf Road



Norlanco Drive looking west (200') at Cloverleaf Road



Norlanco Drive looking west (50') at Cloverleaf Road



Cloverleaf Road looking north (200') at Andrew Avenue/Norlanco Drive



Cloverleaf Road looking north (50') at Andrew Avenue/Norlanco Drive





Cloverleaf Road looking south (200') at Andrew Avenue/Norlanco Drive



Cloverleaf Road looking south (50') at Andrew Avenue/Norlanco Drive



Schwanger Road looking east (200') at Cloverleaf Road



Schwanger Road looking east (50') at Cloverleaf Road



Schwanger Road looking west (200') at Cloverleaf Road



Schwanger Road looking west (50') at Cloverleaf Road



Cloverleaf Road looking north (200') at Schwanger Road



Cloverleaf Road looking north (50') at Schwanger Road



Cloverleaf Road looking south (200') at Schwanger Road



Cloverleaf Road looking south (50') at Schwanger Road



Merts Drive looking east (200') at Cloverleaf Road



Merts Drive looking east (50') at Cloverleaf Road



Cloverleaf Road looking north (200') at Merts Drive



Cloverleaf Road looking north (50') at Merts Drive



Cloverleaf Road looking south (200') at Merts Drive



Cloverleaf Road looking south (50') at Merts Drive





PA 283 EB Ramps looking east (200') at Cloverleaf Road



PA 283 EB Ramps looking east (50') at Cloverleaf Road



PA 283 EB Ramps looking west (200') at Cloverleaf Road



PA 283 EB Ramps looking west (50') at Cloverleaf Road



Cloverleaf Road looking north (200') at PA 283 EB Ramps



Cloverleaf Road looking north (50') at PA 283 EB Ramps



Cloverleaf Road looking south (200') at PA 283 EB Ramps



Cloverleaf Road looking south (50') at PA 283 EB Ramps



PA 283 WB Ramps looking east (200') at Cloverleaf Road



PA 283 WB Ramps looking east (50') at Cloverleaf Road



PA 283 WB Ramps looking west (200') at Cloverleaf Road



PA 283 WB Ramps looking west (50') at Cloverleaf Road



Cloverleaf Road looking north (200') at PA 283 WB Ramps



Cloverleaf Road looking north (50') at PA 283 WB Ramps



Cloverleaf Road looking south (200') at PA 283 WB Ramps



Cloverleaf Road looking south (50') at PA 283 WB Ramps